

# Sporting and Technical Regulations



## 2024 Trico Trans Am Series Sporting and Technical Regulations



<u>Version 1</u>	<u>Published 05/02/2024</u>
<u>Version 2</u>	<u>Published 02/04/2024</u>
<u>Version 3</u>	<u>Published 08/04/2024</u>
<b><u>Version 4</u></b>	<b><u>Published 11/07/2024</u></b>



## 2024 Trico Trans Am Series Sporting & Technical Regulations

A capitalised and italicised word in this document is defined in the FIA International Sporting Code (*Code*), the National Competition Rules (*NCR*), including their Appendices or Attachment L of this document.

Any HEADING is for reference only and has no regulatory effect.

### Contents

<b>S1</b>	<b>TITLE AND JURISDICTION</b> .....	<b>5</b>
	<b>S1.1</b> Title.....	5
	<b>S1.2</b> Authority / Jurisdiction.....	5
<b>S2</b>	<b>ADMINISTRATION</b> .....	<b>5</b>
	<b>S2.1</b> Personnel.....	5
<b>S3</b>	<b>COMPETITOR ELIGIBILITY</b> .....	<b>5</b>
<b>S4</b>	<b>AUTOMOBILE ELIGIBILITY</b> .....	<b>5</b>
	<b>S4.2</b> Replacement <i>Automobile</i> .....	6
<b>S5</b>	<b>DRIVER ELIGIBILITY</b> .....	<b>6</b>
	<b>S5.1</b> General.....	6
	<b>S5.2</b> Substitute <i>Drivers</i> .....	6
<b>S6</b>	<b>SERIES ROUNDS</b> .....	<b>6</b>
<b>S7</b>	<b>SERIES CALENDAR</b> .....	<b>6</b>
<b>S8</b>	<b>ROUND FORMAT</b> .....	<b>7</b>
	<b>S8.1</b> <i>Round Format 1</i> .....	7
	<b>S8.2</b> <i>Round Format 2</i> .....	7
	<b>S8.3</b> <i>Round Format 3</i> .....	7
	<b>S8.4</b> <i>Round Format 4</i> .....	7
	<b>S8.5</b> Variation to Timetable.....	7
<b>S9</b>	<b>GRID DETERMINATION</b> .....	<b>7</b>
<b>S10</b>	<b>START PROCEDURE</b> .....	<b>8</b>
<b>S11</b>	<b>AWARDS AND POINTSCORE</b> .....	<b>8</b>
	<b>S11.1</b> Prizes and Trophies .....	8
	<b>S11.2</b> Series Pointscore .....	8
<b>S12</b>	<b>EVENT OPERATIONS</b> .....	<b>9</b>
	<b>S12.1</b> <i>Series Registration and Entry</i> .....	9
	<b>S12.2</b> <i>Driver and Team Manager Briefing</i> .....	9
	<b>S12.3</b> <i>Parc Fermé</i> .....	9
	<b>S12.4</b> Qualifying .....	9
	<b>S12.5</b> <i>Pit Lane</i> .....	10
	<b>S12.6</b> Removal of <i>Automobile</i> from the <i>Circuit</i> .....	10
	<b>S12.7</b> <i>Driver leaving the Circuit</i> .....	10
	<b>S12.8</b> Radio Communication to/from <i>Automobile</i> .....	10
	<b>S12.9</b> Race Management Channel ( <i>RMC</i> ).....	10

<b>S13</b>	<b>TYRES</b> .....	<b>10</b>
<b>S14</b>	<b>FUEL</b> .....	<b>11</b>
	<b>S14.1</b> General .....	11
	<b>S14.2</b> Refuelling – Garage/Paddock .....	11
<b>S15</b>	<b>AUTOMOBILE MARKINGS</b> .....	<b>12</b>
	<b>S15.1</b> General .....	12
	<b>S15.2</b> <i>Competition Number</i> .....	12
<b>S16</b>	<b>IN-CAR CAMERAS</b> .....	<b>12</b>
<b>S17</b>	<b>RAIN LIGHT</b> .....	<b>13</b>
<b>S18</b>	<b>SCALES OF FACT</b> .....	<b>13</b>
<b>S19</b>	<b>INSTRUMENTS OF FACT</b> .....	<b>13</b>
<b>S20</b>	<b>TESTING RESTRICTIONS</b> .....	<b>13</b>
<b>ATTACHMENT A</b> .....		<b>14</b>
	Automobile Decal Placement .....	14
<b>T1</b>	<b>PREAMBLE</b> .....	<b>15</b>
<b>T2</b>	<b>GENERAL</b> .....	<b>15</b>
	T2.1 Modification .....	15
	T2.2 Eligible Models .....	15
	T2.3 <i>Automobile</i> Component Requirements .....	15
	T2.4 Materials .....	15
	T2.5 <i>Trans Am Automobile</i> Specifications .....	16
<b>T3</b>	<b>CONTROLLED COMPONENTS</b> .....	<b>16</b>
<b>T4</b>	<b>OPTIONAL COMPONENTS</b> .....	<b>17</b>
<b>T5</b>	<b>WEIGHT</b> .....	<b>19</b>
	T5.1 <i>Racing Weight</i> .....	19
	T5.2 <i>Ballast</i> .....	19
<b>T6</b>	<b>CHASSIS AND BODYWORK</b> .....	<b>19</b>
<b>T7</b>	<b>INTERIOR</b> .....	<b>22</b>
<b>T8</b>	<b>SUSPENSION AND STEERING</b> .....	<b>22</b>
	T8.1 Front Suspension .....	22
	T8.2 Rear Suspension .....	23
	T8.3 Steering .....	24
<b>T9</b>	<b>BRAKES</b> .....	<b>24</b>
<b>T10</b>	<b>WHEELS AND TYRES</b> .....	<b>24</b>
<b>T11</b>	<b>ENGINE</b> .....	<b>25</b>
<b>T12</b>	<b>TRANSMISSION AND DRIVETRAIN</b> .....	<b>25</b>
<b>T13</b>	<b>ELECTRICAL &amp; IGNITION SYSTEM</b> .....	<b>26</b>
<b>T14</b>	<b>FUEL AND FUEL SYSTEM</b> .....	<b>27</b>
<b>T15</b>	<b>FIRE EXTINGUISHER SYSTEM</b> .....	<b>27</b>
<b>T16</b>	<b>IN-CAR CAMERAS</b> .....	<b>27</b>
<b>ATTACHMENT B</b> .....		<b>28</b>
	Suspension setup .....	28
<b>ATTACHMENT C</b> .....		<b>29</b>
	Front Splitter Details .....	29

<b>ATTACHMENT D</b> .....	<b>30</b>
Front ride height measurement location.....	30
<b>ATTACHMENT E</b> .....	<b>31</b>
Rear ride height measurement location.....	31
<b>ATTACHMENT F</b> .....	<b>32</b>
Dodge grille.....	32
<b>ATTACHMENT G</b> .....	<b>33</b>
Camaro grille .....	33
<b>ATTACHMENT H</b> .....	<b>34</b>
Mustang grille.....	34
<b>ATTACHMENT I</b> .....	<b>35</b>
One-piece fibreglass splitter – Wear strip .....	35
<b>ATTACHMENT J</b> .....	<b>36</b>
Timing device fitment location .....	36
<b>ATTACHMENT K</b> .....	<b>37</b>
Authorised TA2 Shock Repair Centres (ATSRC).....	37
<b>ATTACHMENT L</b> .....	<b>38</b>
Definitions .....	38

## 2024 Trico Trans Am Series Sporting Regulations

### S1 TITLE AND JURISDICTION

#### S1.1 Title

This *Series* will only be known as and referred to as the “2024 Trico Trans Am Series”.

#### S1.2 Authority / Jurisdiction

1.2.1 Each *Event* incorporating a *Round* of the 2024 Trico Trans Am Series (*Series*) will be held under the FIA International Sporting Code including Appendices; the National Competition Rules (*NCR*) and Circuit Race Standing Regulations (*CRSR*) of *Motorsport Australia*; the Sporting and Technical Regulations issued for this *Series* by *Motorsport Australia*; *Supplementary Regulations* issued by the *Organiser* for each *Event*; any Bulletin issued by the Stewards and any Driver Briefing Notes and instructions issued by the Race Director or the Clerk of the Course at an *Event*.

1.2.2 This *Series* has been sanctioned by *Motorsport Australia* as an *Authorised Series*.

1.2.3 Australian Racing Group Pty Ltd has been appointed as the Category Manager (*CM*) by *Motorsport Australia* for this *Series*.

**Contact Details:** Graham Sattler  
Australian Racing Group  
Phone: 0499 977 982  
Email: [graham@australianracinggroup.com](mailto:graham@australianracinggroup.com)

### S2 ADMINISTRATION

#### S2.1 Personnel

The following personnel have been appointed to the *Series* by *Motorsport Australia* and/or the *CM* and have the authority to administer the various aspects of these regulations as detailed in the *CRSR*.

Race Director ( <i>RD</i> )	Matt Balcombe
Technical Delegate ( <i>TD</i> )	Troy Hungerford
Category Administrator ( <i>CA</i> )	Graham Sattler
Driving Standards Advisor ( <i>DSA</i> )	Chris Pither
Technical Advisor ( <i>TA</i> )	Cameron Sendall

### S3 COMPETITOR ELIGIBILITY

To be eligible to compete in the *Series*, each *Competitor* must hold a current *Motorsport Australia Competitor Licence* and be a party to the 2024 Trico Trans Am Series Terms of Participation Agreement and Series Entry Contract.

### S4 AUTOMOBILE ELIGIBILITY

Each *Automobile* must comply with the requirements of the 2024 Trico Trans Am Series Technical Regulations and the List of Eligible Automobiles (refer Article S4.1) and be registered for the *Series* with the *CM* as per the Series Entry Contract to be eligible to compete in the *Series*.

Except where permitted in these regulations, each *Automobile* must comply with the Technical Appendix of the *Manual*.

#### S4.1 List of Eligible Automobiles

Model
Ford Mustang
Chevrolet Camaro
Dodge Challenger

#### S4.2 Replacement *Automobile*

Prior to the commencement of the first qualifying session at each *Round*, a *Competitor* may nominate a substitute *Automobile* that will be permitted to compete in the remainder of the *Event* subject to the approval of the Stewards and the *CM*.

### S5 DRIVER ELIGIBILITY

#### S5.1 General

- 5.1.1 To be eligible to compete in the *Series*, each *Driver* must be a minimum of 17 years of age and hold the minimum of a current *Motorsport Australia Circuit Licence* without a Provisional endorsement.
- 5.1.2 Each *Driver* must be party to the 2024 Trico Trans Am Series Terms of Participation Agreement.
- 5.1.3 The *CM* reserves the right to prohibit any *Driver* from competing in any *Round* if, in the sole opinion of the *CM*, the *Driver's* previous actions have resulted in the category or the *Series* being brought into disrepute.

#### S5.2 Substitute *Drivers*

Prior to the commencement of the first qualifying session at each *Round*, a *Competitor* may nominate a substitute *Driver* who may be permitted to compete in the remainder of the *Event* subject to the approval of the Stewards and the *CM*.

### S6 SERIES ROUNDS

The *Series* will be conducted over 7 *Rounds* as detailed in the *Series Calendar* below.

### S7 SERIES CALENDAR

The *Series* will be conducted over the following *Rounds*:

Round	Date	Circuit	Round Format
1	9 – 11 February	Sandown	1
2	15 – 17 March	Symmons Plains	3
3	12 – 14 April	Phillip Island	1
4	31 May – 2 June	The Bend Motorsport Park	3
5	12 – 14 July	Queensland Raceway	<del>2</del> 3
6	8 – 10 November	Mount Panorama	<del>2</del> 4
7	14 - 17 November	Adelaide Parklands	1

Note: The above calendar is subject to change. The *CM* will advise each *Competitor* of any change.

## S8 ROUND FORMAT

The number, length and format of *Track* sessions will ultimately be negotiated between the *CM* and the *Organiser* prior to a *Round* of the *Series* and will be advised in the relevant *Supplementary Regulations* issued for an *Event*. Generally, the format of each *Round* will be as follows:

### S8.1 Round Format 1

- 8.1.1 Practice A minimum of 2 x 20-minute sessions.
- 8.1.2 Qualifying A minimum of 1 x 20-minute session.
- 8.1.3 Races 2 x 25-minute races expressed as a number of laps; and  
1 x 30-minute race expressed as a number of laps.

### S8.2 Round Format 2

- 8.2.1 Practice A minimum of 2 x 20-minute sessions.
- 8.2.2 Qualifying A minimum of 1 x 20-minute session.
- 8.2.3 Races 2 x 25-minute races expressed as a number of laps; and  
1 x 100 km race expressed as a number of laps.

### S8.3 Round Format 3

- 8.3.1 Practice A minimum of 2 x 20-minute sessions.
- 8.3.2 Qualifying A minimum of 1 x 20-minute session
- 8.3.3 Races 4 x 25-minute races expressed as a number of laps.

### S8.4 Round Format 4

- 8.4.1 Practice [A minimum of 1 x 30-minute session.](#)
- 8.4.2 Qualifying [A minimum of 1 x 20-minute session](#)
- 8.4.3 Races [2 x 45-minute races expressed as a number of laps.](#)

### S8.5 Variation to Timetable

The timetable may be varied at any time due to exceptional circumstances only with the prior approval of the Stewards.

## S9 GRID DETERMINATION

- 9.1 The grid for Race 1 and Race 2 at each *Round* will be determined as detailed in the *CRSR*.
- 9.2 The grid for Race 3 at *Rounds* [2, 4 and 5](#) ~~and 4~~ will be determined as detailed in the *CRSR*.
- 9.3 The grid for Race 3 at each of *Rounds* 1, 3, ~~5, 6~~ and 7 will be determined by the aggregate *Series* points awarded to each *Driver* for Race 1 and Race 2. If more than 1 *Driver* has the same number of points, each such *Driver* will be placed in order of their fastest qualifying lap time.
- 9.4 The grid for Race 4 at *Rounds* [2, 4 and 5](#) ~~and 4~~ will be determined by the aggregate *Series* points awarded to each *Driver* for Race 1, Race 2 and Race 3. If more than 1 *Driver* has the same number of points, each such *Driver* will be placed in order of their fastest qualifying lap time.
- 9.5 If for any reason the Qualifying session is not conducted or the qualifying lap times are not able to be published, each grid position for Race 1 will be determined by the fastest lap time achieved by each *Automobile* in the practice session/s or other method as determined by the Stewards in consultation with the *CM*.

## S10 START PROCEDURE

Unless specified otherwise in the event regulations, the *Start* procedure for each race will be a Championship rolling *Start* as detailed in the *CRSR* except that pit crew may not access the grid and only the 1-minute board will be displayed. This will be displayed when the first *Automobile* stops on the grid at the end of the reconnaissance lap. The green flag will be displayed by the Starter to commence the formation lap when the last *Automobile* stops on the grid.

## S11 AWARDS AND POINTSCORE

### S11.1 Prizes and Trophies

Prizes, trophies and awards will be as determined by the *CM* and will be advised to each *Competitor*.

### S11.2 Series Pointscore

11.2.1 For Race 1 and Race 2 of each *Round*, points will be awarded to each *Driver* based on their outright finishing position for each race as follows:

Finishing position	Points	Finishing position	Points
1 <sup>st</sup>	40	11 <sup>th</sup>	10
2 <sup>nd</sup>	35	12 <sup>th</sup>	9
3 <sup>rd</sup>	31	13 <sup>th</sup>	8
4 <sup>th</sup>	27	14 <sup>th</sup>	7
5 <sup>th</sup>	23	15 <sup>th</sup>	6
6 <sup>th</sup>	20	16 <sup>th</sup>	5
7 <sup>th</sup>	17	17 <sup>th</sup>	4
8 <sup>th</sup>	15	18 <sup>th</sup>	3
9 <sup>th</sup>	13	19 <sup>th</sup>	2
10 <sup>th</sup>	11	20 <sup>th</sup> and over	1

11.2.2 For Race 3 and Race 4 (where applicable) of each *Round*, points will be awarded to each *Driver* based on their outright finishing position for each race as follows:

Finishing position	Points	Finishing position	Points
1 <sup>st</sup>	60	11 <sup>th</sup>	15
2 <sup>nd</sup>	53	12 <sup>th</sup>	14
3 <sup>rd</sup>	47	13 <sup>th</sup>	12
4 <sup>th</sup>	41	14 <sup>th</sup>	11
5 <sup>th</sup>	35	15 <sup>th</sup>	9
6 <sup>th</sup>	30	16 <sup>th</sup>	8
7 <sup>th</sup>	26	17 <sup>th</sup>	6
8 <sup>th</sup>	23	18 <sup>th</sup>	5
9 <sup>th</sup>	20	19 <sup>th</sup>	3
10 <sup>th</sup>	17	20 <sup>th</sup> and over	2



- 11.2.3 Unless specified otherwise in the *Supplementary Regulations* at any *Round*, points will only be awarded to the *Drivers* classified as finishers in the final results of each race conducted at each *Round*.
- 11.2.4 The results for each *Round* will be determined by the number of points scored by each *Driver* at that *Round*.
- 11.2.5 The lowest point scoring race for each *Driver* will not be included when determining that *Driver's* points total for the *Series*. The *Driver* gaining the highest points total for the *Series* will be declared the winner of the *Series*.
- 11.2.6 If there is a tie at the end of any *Round*, the final positions for that *Round* will be determined by comparing the results of each of the tied *Drivers* in the final race of that *Round* with the *Driver* with the higher finishing position being awarded the higher *Round* position.
- 11.2.7 If there is a tie at the end of the *Series*, the final positions will be determined by comparing the race results achieved by each tied *Driver*, with the *Driver* with the highest number of first places being awarded the higher *Series* position. If a tie still exists, it will be resolved by comparing the number of second, third or fourth places (and so on) achieved by each tied *Driver* until all positions have been determined.

## S12 EVENT OPERATIONS

### S12.1 Series Registration and Entry

The *Series* will operate under the Motorsport Australia Series Registration and Entry Process. Series Registration and Entry Forms will be available from the *CM* with document checking being conducted by the *CM* prior to the first official *Track* session at each *Round*.

### S12.2 Driver and Team Manager Briefing

- 12.2.1 Each *Driver* and *Team Manager* must attend the compulsory *Drivers' briefing*.
- 12.2.2 The time and location of this briefing will be detailed in the *Supplementary Regulations* for each *Event*.
- 12.2.3 The attendance sheet must be signed by each *Driver* and *Team Manager* to confirm attendance.
- 12.2.4 Other compulsory briefings may be convened as required and will be advised to each *Competitor* accordingly.

### S12.3 Parc Fermé

- 12.3.1 Each *Automobile* and *Driver*, including those remaining in *Pit Lane*, must proceed directly to the designated *Parc Fermé* area via the most direct route (or as directed by Officials) at the conclusion of qualifying, and without interference from any third party (other than an Official).
- 12.3.2 Each *Automobile* and *Driver* completing each race must proceed directly to the designated *Parc Fermé* area (or as directed by Officials) at the conclusion of the race, and without interference from any third party (other than an Official).
- 12.3.3 An *Automobile* may not be removed from *Parc Fermé* and no third party is permitted to enter the *Parc Fermé* except with the permission of the *TD* or the Chief Scrutineer.

### S12.4 Qualifying

- 12.4.1 The order in which *Automobiles* pre-grid for a qualifying session will be determined by the fastest lap time achieved by each *Automobile* in the practice session/s at the *Event*.
- 12.4.2 During qualifying, an *Automobile* may not return to the paddock area or pit lane garage without the permission of the *TD*. If an *Automobile* exits *Pit Lane* to the paddock or enters a pit lane garage during qualifying it will be prohibited from re-joining that session.

### S12.5 Pit Lane

Each pit crew member is required to sign a Pit Lane Indemnity Form prior to the first *Track* session and to display identification as and if required by the *Organiser*.

### S12.6 Removal of *Automobile* from the *Circuit*

Following the commencement of the first practice session, it is prohibited to remove any *Automobile* from the *Circuit* prior to the release of all *Automobiles* from the *Parc Fermé* established following the final race of that *Round* without the prior written approval of the *TD*.

### S12.7 Driver leaving the *Circuit*

Any *Driver* leaving the *Circuit* prior to 1 hour after the completion of the last *Track* session for the *Series* for that day must notify the *CM* or a *Series* official.

### S12.8 Radio Communication to/from *Automobile*

Two-way radio communication between the *Driver* and a member of the pit crew is mandatory at all times whilst the *Automobile* is on the *Track*.

### S12.9 Race Management Channel (*RMC*)

12.9.1 A minimum of 1 team member for each competing *Automobile* must monitor *RMC* at all times during practice, qualifying and racing.

12.9.2 This team member must monitor *RMC* from 15 minutes prior to the time *Automobiles* are released from the pit/paddock area to the marshalling area [until 30 minutes after the end of practice, qualifying and racing](#).

12.9.3 Each *Track* related message must be relayed to each *Driver*.

## S13 TYRES

13.1 For the duration of each *Round*, each *Automobile* must only be fitted with Hoosier tyres as detailed in the following table:

Tyre	Size	Type	Compound	Wheel diameter
Dry	27.0/10.0 x 15	Bias Ply	3045	15"
Wet	27.0/10.0 x 15	Bias Ply	Wet	15"

13.2 Each tyre detailed on the list above must only be supplied by the *Series* tyre supplier and/or their approved agent:

Hoosier Racing Tire Australia (Max Dumesny Motorsport)

17 Blind Road,

Nelson NSW 2765.

Phone: 02 9679 1990

Fax: 02 9679 1187

Mobile: 0407 108 946

13.3 With the exception of wear resulting from normal usage, each tyre must remain unmodified save for cleaning. It is permitted to use a heat gun or similar device/s to clean a single strip across the width of a tyre of a maximum width of 50 mm to measure the tread depth. The use of a heat gun or similar device/s to clean a tyre is otherwise prohibited during a *Round*.

- 13.4 At each *Round*, a maximum of 5 dry tyres will be permitted for use by each *Driver* over all practice sessions. For a *Driver* at their first *Round*, the 5 practice tyres may be new tyres. For each subsequent *Round*, the practice tyres must be marked tyres, either practice or qualifying/race, from a previous *Round*. Each of these tyres must be marked prior to the commencement of the first practice session at each *Round*.
- 13.5 At each *Round*, a maximum of 6 dry tyres, of which 6 may be new, will be permitted for use by each *Automobile* during all qualifying sessions and races. Each of these tyres must be marked prior to the first qualifying session at each *Round*.
- 13.6 With the exception of treaded tyres used on a damp or wet track, these marked dry tyres are the only tyres permitted to be used on that *Automobile* during any qualifying session or race at that *Round*.
- 13.7 Within 1 hour from the completion of the final practice session and prior to qualifying at each *Round*, each *Competitor* must present their dry tyre allocation for marking at the front of their respective garage/paddock bay.
- 13.8 Each wheel must be clearly marked on the outside of the wheel rim with the *Automobile's Competition Number* before presenting for tyre fitting.
- 13.9 Each *Competitor* is responsible for ensuring that each tyre is marked or re-marked as appropriate. If a tyre is not marked for any reason or the markings become illegible, the *Competitor* must notify the *TD* or their nominee immediately.
- 13.10 Each *Competitor* is permitted to replace a marked tyre if the *TD* is satisfied that due to exceptional circumstances the tyre in question can no longer be used. The *TD* will ensure that the tyre to be replaced has been rendered unusable and that the replacement tyre is of the same specification and of similar wear to the tyre being replaced.
- 13.11 If a *Competitor* is permitted to replace a marked tyre, the *Automobile* concerned must start the next race at that *Round* as follows:
- 1<sup>st</sup> replacement tyre – with a loss of 10 grid places; and
  - 2<sup>nd</sup> replacement tyre – from the rear of the grid.
- If more than 2 replacement tyres are permitted, the *Automobile* must start each remaining race at that *Round* from the rear of the grid.
- 13.12 The use of any tyre heating, heat retention device or chemical treatment is prohibited.
- Note:** The *TD* will be the sole arbiter with regard to the interpretation and application of these tyre regulations and any decision made by the *TD* in this regard will not be the subject of any protest.

## S14 FUEL

### S14.1 General

- 14.1.1 For the duration of a *Round*, each *Automobile* must only use commercially available 98 RON fuel supplied by the approved event fuel supplier (RaceFuels).
- 14.1.2 Any fuel additive is prohibited.

### S14.2 Refuelling – Garage/Paddock

- 14.2.1 When refuelling or undertaking any activity with fuel, each *Competitor* must comply with the following procedure:

- 14.2.1.1 The *Automobile*'s engine must be switched off;
- 14.2.1.2 At least 1 crew member must be designated as a fire attendant and in possession of at least 1 x 4.5 kg dry powder fire extinguisher;
- 14.2.1.3 The designated fire attendant must not perform any other task during the refuelling procedure; and
- 14.2.1.4 A drip/catch mat/tray capable of containing any spillage must be positioned below the refuelling point of the *Automobile*.

## S15 AUTOMOBILE MARKINGS

### S15.1 General

In addition to the requirements detailed in the decal placement diagram in Attachment A of these regulations, each *Automobile* must comply with any other decal required by Technical Appendix - *Schedule A, B, C and K* of the *Manual*.

### S15.2 Competition Number

- 15.2.1 The allocation of a *Competition Number* for each *Automobile* is solely the responsibility of the *CM*, which will maintain a register of all *Competition Numbers* allocated to, or reserved for, any *Automobile*.
- 15.2.2 The requirements of Technical Appendix, *Schedule K* regarding side *Competition Numbers* will not apply to this *Series*. The *Competition Number* must be displayed clearly as large and bold as possible on each side of the *Automobile*.
- 15.2.3 The *CM* will be the sole arbiter as to whether the *Competition Number* on the side of the *Automobile* is acceptable.
- 15.2.4 The *Competition Number* must be displayed on the right hand, top corner of the windscreen below the windscreen banner and on the left hand, top corner of the rear window. Each number must be yellow and a minimum of 100 mm high.

## S16 IN-CAR CAMERAS

- 16.1 Each *Automobile* must be fitted with an in-car camera system as detailed in the 2024 Trico Trans Am Series Technical Regulations.
- 16.2 The in-car camera system must be switched on and remain fully operational to record video images for the duration of each practice session, qualifying session, passenger ride session and race.
- 16.3 It is the responsibility of each *Competitor* to ensure that each camera is in operational condition and is turned on prior to each *Track* session and turned off following each *Track* session.
- 16.4 Each in-car camera must be installed and aligned by the *Competitor* in accordance with the requirements of the *CM*. It is prohibited to adjust the alignment of any camera once set by the *CM* or *TA*.
- 16.5 Access to the video images recorded by the in-car camera system must be provided to the *CM, RD, DSA* or *TD* at any time upon request.
- 16.6 The video images recorded by any in-car camera system must not be distributed without the prior express approval or release by the *CM* or *TD*.
- 16.7 An SD card must not be removed from any camera until authorised by the *CM* or *TD*.
- 16.8 Each SD card must be marked with the *Competition Number* of the *Automobile*.

## **S17 RAIN LIGHT**

The rain light fitted to each *Automobile* must be illuminated at all times whilst the *Automobile* is fitted with wet weather tyres and is being driven on the *Track* or as otherwise directed by Race Control.

## **S18 SCALES OF FACT**

The *CM* will provide a set of scales for the purpose of weighing of *Automobiles* for the entire *Series*. These scales will be the Scales of Fact for regulatory control.

## **S19 INSTRUMENTS OF FACT**

The *CM* and/or *TD* may provide measuring devices as Instruments of Fact for regulatory control of specific components. Each of these Instruments of Fact will be nominated as such by the *TD*.

## **S20 TESTING RESTRICTIONS**

- 20.1 Unless otherwise approved by the *CM*, any *Automobile* associated with the *Series* may only undertake a Test Day at Queensland Raceway, Morgan Park, Sydney Motorsport Park, Wakefield Park, Winton Raceway, Symmons Plains or The Bend Motorsport Park.
- 20.2 Unless otherwise approved by the *CM*, any *Automobile* associated with the *Series* is prohibited to be driven on any *Circuit* that is hosting a *Round* during the 7 days prior to the commencement of that *Round*.
- 20.3 The *CM* will be the sole arbiter as to whether an *Automobile* is associated with the *Series*.

# ATTACHMENT A

## Automobile Decal Placement

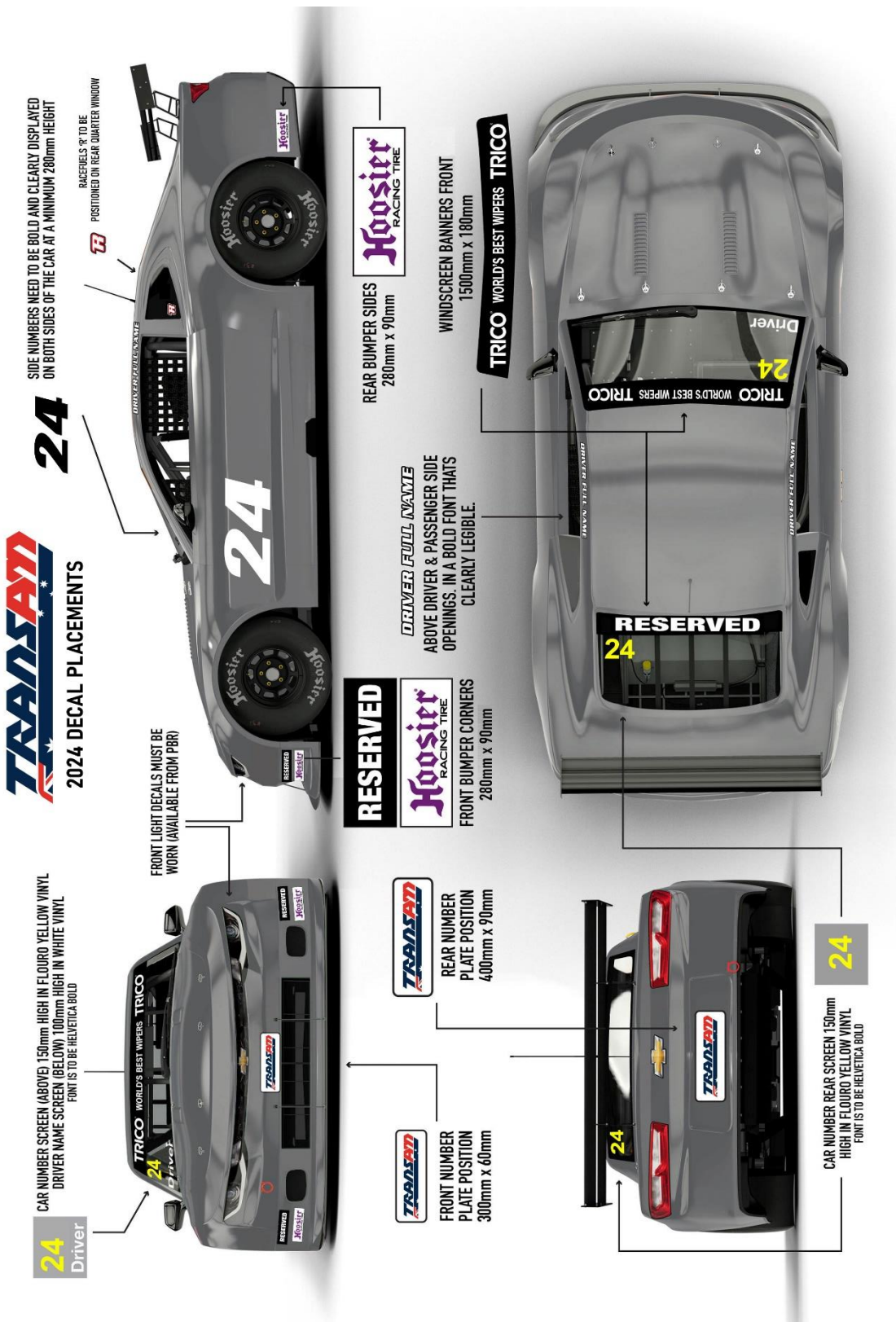

# 2024 Trico Trans Am Series Technical Regulations

## T1 PREAMBLE

The 2024 Trico Trans Am Series (*Series*) is for Trans Am *Automobiles* in accordance with the 2024 Trico Trans Am Series Technical Regulations.

## T2 GENERAL

### T2.1 Modification

2.1.1 Each *Automobile* must remain unmodified, in compliance with all aspects of these Technical Regulations and identical in all respects to the production make/model as supplied by the original vehicle manufacturer.

2.1.2 Any aspect relating to the construction, modification and/or preparation of the *Automobile* including the location, fitment/mounting of any ancillary component that is not specifically authorised in the present regulations is prohibited.

### T2.2 Eligible Models

2.2.1 Eligible models of *Automobiles* are listed in the 2024 Trico Trans Am Series Sporting Regulation S4.1 List of Eligible Automobiles.

2.2.2 Additional models of *Automobile* may be added to the List of Eligible Automobiles upon recommendation by the *CM* and subsequent approval by *Motorsport Australia*.

2.2.3 The *CM* may invite other *Automobile* makes/models at their discretion. Any invited *Automobile* will be subject to any conditions stated by the *CM*.

### T2.3 *Automobile* Component Requirements

2.3.1 In all cases, when interpreting the present regulations, any component on an *Automobile* eligible to compete must be original equipment supplied by the manufacturer or *Controlled Component* supplier unless otherwise specified in these regulations.

2.3.2 Nuts and bolts: Throughout the *Automobile*, any nut, bolt, screw may be replaced by an equivalent length and material nut, bolt, screw and have any kind of locking device (washer, lock nut etc).

The use of a titanium nut or bolt is prohibited.

It is permitted to replace a rivet (i.e. pop or blind rivet) with another type of fastener (i.e. screw, bolt, nutsert/rivet nut) and the area taken up by a rivet may be modified only to accept the other type of fastener.

2.3.3 Any component *Seal* fitted (i.e. engine *Seal*, *ECM Seal*) must not be removed without the written permission of the *TD*. Any *Seal* damaged or broken must be reported to the *TD*.

### T2.4 Materials

2.4.1 Unless specifically authorised in these regulations, the use of carbon fibre or carbon Kevlar® composite materials is prohibited.

2.4.2 Any race seat, safety intrusion component, door trim, front air dam, panel replacement, bumper bar and brake scoop is permitted to utilise GRP/carbon fibre/carbon Kevlar® composite materials as approved by the *CM*.

## T2.5 Trans Am *Automobile* Specifications

<b>Wheelbase</b>	2640 mm plus or minus 10 mm
<b>Wheel Track Front</b>	2000 mm plus or minus 25.4 mm (outside of tyre to outside of tyre)
<b>Wheel Track Rear</b>	2000 mm plus or minus 25.4 mm (outside of tyre to outside of tyre)
<b>Minimum <i>Racing Weight</i></b>	1250 kg (including <i>Driver</i> )

## T3 **CONTROLLED COMPONENTS**

- 3.1 *Controlled Components* have been nominated to assist in equalising performance of all *Automobiles*.
- 3.2 The *Controlled Components* listed in the table below must be fitted to each *Automobile*.
- 3.3 All suspension components fitted to an *Automobile* are controlled and must be purchased through TA2 Australia.

<b>Controlled Component</b>	<b>Part Number</b>
Upper Control arm (front)	2213407
Lower Control arm (RH front)	229926R
Lower Control arm (LH front)	229926L
Lower ball joints	22410
Upper ball joints	22320
Front sway bar 170	2373134
Front sway bar 250	23732
Front Up-right R/H (stub)	346104
Front Up-right L/H (stub)	346104L
New Complete LS Engine	LSCC
Electronic Control Module (ECM)	As supplied, sealed and numbered by PBR
Axle L/H	TG3001-34
Axle R/H	TG3001-34
Caster rod	22945A-18
Brake Rotor Wilwood RHF	160-11839
Brake Rotor Wilwood LHF	160-11840
Brake Rotor Wilwood RHR	160-13499
Brake Rotor Wilwood LHR	160-13500
Brake Caliper – Wilwood Front	120-13948-N (GN6)R
Brake Caliper – Wilwood Rear	120-13263-N (Superlite 4)
Brake Pads Circo HD Front TA2 Competition Spec	MB1812-20-M207*
Brake Pads Circo MD Front TA2 Competition Spec	MB1812-20-M111*
Brake Pads Circo Rear TA2 Competition Spec	MB2690-20-S83*
Brake Bias Adjuster (Howe)	52620
Front Hub	205800
Rear Hub	205300



Basset wheel rim	B50L55
Hyper coil springs F&R	Linear rate only part #1810BO-Spring Rates
Penske Shock Absorber	PK7500COSA
All Body Panels	5 Star/ PBR approved
Tiger Quick Change Rear End	TG20102
Windscreen Camaro	FS81131-63343
Windscreen Mustang	FS81321-63343
Windscreen Challenger	B8019D
Gearbox (Sealed) PEX	G101A-PBR
LS Engine (Sealed) PEX	LSCC-PBR
Heavy duty clutch kit (Red cover inc. steel flywheel)	TA2-0023
Hoosier Slick Tyres	3045
Tiger Quick change PEX	TG20102 PBR
Detroit Locker	TG2403 or TG2430 Purple spring version
Fuel sample valve	XARO15631

**\*Note:** Only TA2 Competition Spec Circo pads are permitted for use during qualifying and races.

## T4 **OPTIONAL COMPONENTS**

The *Optional Components* listed in the table below may be fitted to an *Automobile*.

Part Number	Component Description	Availability
244000-CHRO	Driveshaft w/Upgraded chrome moly slip yoke	Purchase option
32680	Howe shifter boot	STD fitment on 2019+ models
30799DET1	Watts Link chassis plate (Allows lower bar angle)	STD fitment on 2019+ models
52696	Howe Pro Brake pedal	Purchase option
524358	Remote clutch reservoir conversion	STD fitment on 2020+ models
52350	Improved accelerator pedal	STD fitment from mid-2019 models
52359	TA2 pedal stop accelerator	As above
524373	Aluminium master cylinder cap (Replaces plastic cap)	Purchase option
B96100 & B96101	Steel perforated rock guards (Replace plastic part)	STD fitment 2020+ models
GF2314 1-2/3-4	Shift lever (slows shift down, limits jamming)	Purchase option
MOTEC LOGGING	Computer Programming	Purchase option
MOTEC TPS	TPS Extension Kit	Purchase option
MOTEC 18037	C127 Race Display Screen 7"	Purchase option
TA2-0009	Brake pressure gauge kit (Brake bias display)	Purchase option
WW260-10278	Wilwood brake master cylinder 7/8"	Purchase option
WW260-10279	Wilwood brake master cylinder 1"	Purchase option
WW260-10280	Wilwood brake master cylinder 1 1/8"	Purchase option
TA2-0020	Alternator 110-amp upgrade (Replaces Powermaster part)	STD fitment on 2019 + models

TA2-0026	Mid gearbox skid plate	Purchase option
TA2-0031	Transmission cooler pump kit	Purchase option
TA2-0032	4" Brake cooling duct kit	STD fitment on 2019+ models
TA2-0034	Brake duct box – Dodge Challenger body only	Purchase option
TA2-0033-C	Grille inserts for upper nose - Camaro (Additional grille opening for cooling)	Purchase option
TA2-0033-M	Grille inserts for upper nose - Mustang (Additional grille opening for cooling)	Purchase option
TA2-0033	Grille opening for Dodge	Purchase option
TA2-0043	Fire system kit (Replaces 2 bottle system)	Updated when system/bottles are out of service date
TA2-0046	Holley valve cover option (Red, Black or Orange)	Purchase option
TA2-0047	PWR oil cooler with 9" skew blade fan	Purchase option
PWO122866	PWR Engine Oil Cooler - Plate & Fin 280 x 279 x 37mm (32 Row)	Purchase option
TA2-0049	Pinion bearing spacer	STD fitment on 2019+ models
TA2-0051-C	Camaro one piece nose cone fiberglass	Purchase option
TA2-0051-M	Mustang one piece nose cone fiberglass	Purchase option
TA2-0051-D	Dodge one piece nose cone fiberglass	Purchase option
TA2-0072 (Holley)	Engine valve cover breather kit	Purchase option
TA2-0072(STD)	Engine valve cover breather kit	Purchase option
TA2-0076	Air box assembly (alternate)	Purchase option
TA2-ED02H SOILID	Solid centre clutch disc 280mm	Purchase option
TA2-0108CAM	Early Camaro Grille inlet	Purchase option
TA2-0108MUS/CAM	Mustang/Late Camaro/Dodge grille inlet	Purchase option
TA2-0107	Air Duct intake pipe fitting	Purchase option
TA2-00111MUS/LH	Mustang LH QTR window duct	Purchase option
TA2-00111-MUS/RH	Mustang RH QTR window duct	Purchase option
TA2-00111CAM/LH	Camaro LH QTR window duct	Purchase option
TA2-00111CAM/RH	Camaro RH QTR window duct	Purchase option
RP300M-34	Axel solid billet 34"	Purchase option
RPEN26-34	Axel EN26 Billet 34"	Purchase option
TA2-0112	Throttle Pedal Support Plate	Purchase Option
60201	1/16" thick shim	Purchase Option
SA43195 / SA41920	Coil over spring rubber insert (medium/hard)	Purchase Option
GFLT592024	Gearbox – Half Shaft (H/S)	Purchase Option/STD fitment on March 2024+ models
GSRM2918	Gearbox – 1 <sup>st</sup> Gear Set	Purchase Option/STD fitment on March 2024+ models
GSRL2420	Gearbox – 2 <sup>nd</sup> Gear Set	Purchase Option/STD fitment on March 2024+ models
GSRL2324	Gearbox – 3 <sup>rd</sup> Gear Set	Purchase Option/STD fitment on March 2024+ models
GSR0318B	Gearbox - Spacer	Purchase Option/STD fitment on March 2024+ models
GSR08PL	Gearbox – Face Plate	Purchase Option/STD fitment on March 2024+ models

GF2314	Gearbox – Shifter Plates - Long	Purchase Option/STD fitment on March 2024+ models
TA2-0057	Wear Strip, one-piece fibreglass splitter	Purchase Option
TA2-0057D		
TA2-0057 LONG		
TA2-0057D LONG		

## T5 WEIGHT

### T5.1 *Racing Weight*

When fitted with the Hoosier Dry Tyre the *Racing Weight* for an *Automobile* at any time, including the *Driver* with helmet and wearing all apparel, must be equal to or greater than 1250 kg.

When fitted with the Hoosier Wet Tyre the *Racing Weight* for an *Automobile* at any time, including the *Driver* with helmet and wearing all apparel, must be equal to or greater than 1240 kg.

### T5.2 *Ballast*

- 5.2.1 *Ballast* may be used to achieve the *Racing Weight* requirement, and if used must comply with *Motorsport Australia* requirements.
- 5.2.2 *Ballast* must be in block form.
- 5.2.3 No single block of *Ballast* may weigh more than 15 kg.
- 5.2.4 Any *Ballast* used must be within the *Chassis* rails side to side, within the centre line of the front and rear wheels and be directly bolted to the *Chassis* plates provided.
- 5.2.5 Any *Ballast* block must be painted a bright colour and be identified either by the *Automobile Chassis* number or *Competition Number*.
- 5.2.6 *Ballast* is prohibited in the *Driver* compartment.
- 5.2.7 Movable weight is prohibited.
- 5.2.8 Weight trays other than those provided on the *Chassis* by Howe are prohibited.
- 5.2.9 *Ballast* must be fixed as described in the definition of *Ballast Retention* in the Technical Appendix, *Schedule A* of the *Manual*.

## T6 CHASSIS AND BODYWORK

### T6.1 *Chassis*

- 6.1.1 The Howe approved *Chassis* must be used and the following restrictions apply:
  - 6.1.1.1 Modification to the *Chassis*/frame is prohibited.
  - 6.1.1.2 Additional mounts may be fitted with prior written approval of the *TD*.
  - 6.1.1.3 The *Chassis* must remain in good order and provide the *Driver* with protection in the case of an incident.
  - 6.1.1.4 Any damage to a major *Chassis* member must be repaired or replaced to the highest standards and meet the satisfaction of the *TD*.
  - 6.1.1.5 Any *Automobile* involved in a major incident may be subject to scrutineering prior to being allowed to compete at any future *Event*.

- 6.1.1.6 Any modification to a suspension pick-up point, engine mounting point or mounting plate is prohibited.
- 6.1.1.7 The bottom hole (3<sup>rd</sup>) in the 3 link front *Chassis* plate is a global addition to the later model (metallic grey) *Chassis* and its use is prohibited. Only the top and 2<sup>nd</sup> hole are permitted to be used for suspension set up. Refer to Attachment B.

## **T6.2 Bodywork**

- 6.2.1 Repairs to any body panel must not change the shape of the panel to aid in aerodynamic performance.
- 6.2.2 It is prohibited to apply any tape, vinyl or other material to the panel gaps of the body panels.
- 6.2.3 It is prohibited to manipulate or modify the body panels or their fitment.
- 6.2.4 It is prohibited to modify or manipulate any *Bodywork* mounting structure. Each *Bodywork* mounting structure (i.e. support strut, primary or secondary frame, or other structure), including any mounting structure locking mechanism, must be fitted and maintain the *Bodywork* shape in its entirety as per the manufacturer's specifications. *Bodywork* width may be checked by the *TD* and must comply with the manufacturer's specifications.  
  
Accident damage repair must ensure compliance with this regulation or as otherwise authorised at an *Event* by the *TD*, in which case the *TD* will be the sole arbiter during an *Event* with regard to the interpretation and application of these regulations and any decision made by the *TD* in this regard will not be the subject of any protest.
- 6.2.5 The cowl panel (below windscreen) must remain unchanged and all engine intake air or cooling air must come through the front bumper grille section only.
- 6.2.6 The grille must comply with the following:
  - 6.2.6.1 Any grille insert must be the permitted TA2 specification insert only and located within the grille airbox frontal area. Bumper sections may not be modified.
  - 6.2.6.2 The original profile of the grille as viewed from the top, sides and front must be retained.
  - 6.2.6.3 Grille mesh must be steel or stainless-steel material ~~is free and can be changed~~ with a consistent mesh weave and aperture type, noting that small aperture mesh should not impede air flow to radiator nor large mesh allow debris to pass through causing radiator damage. Only one layer and type of mesh is permitted.
  - 6.2.6.4 It is permitted to add grille openings in the upper section in accordance with Attachments F, G and H.
- 6.2.7 Quarter panels must remain un-modified other than repairs to damage.
- 6.2.8 Rear boot/trunk must remain un-modified other than repairs.
- 6.2.9 Rear wing mounts must remain unmodified.
- 6.2.10 Except for additional fasteners permitted on the hood section, the hood must remain unmodified.
- 6.2.11 Internal tinwork must remain unchanged from original standard design and provide the *Driver* with safe insulation from the driveline and engine bay area.
- 6.2.12 A positive fire wall on all four sides of the *Driver* is mandatory.
- 6.2.13 The floor must remain minimum 1/8" magnetic steel plate.
- 6.2.14 Tinwork must be of neat appearance and not have sharp edges.
- 6.2.15 Windscreens must be fitted, and:

- 6.2.15.1 The front windscreen must be TA2 specification/Five Star polycarbonate (clear) sheet and not have any hole other than the mounting holes.
- 6.2.15.2 The rear windscreen must be TA2 Specification/Five Star screen only
- 6.2.15.3 Any replacement windscreen must be TA2 specification/Five Star screen only.
- 6.2.15.4 Windscreen protectors are permitted.
- 6.2.16 Aerodynamics
  - 6.2.16.1 The standard factory front splitter/undertray is permitted (P/N FS81001-41851) or alternate material (paper rock) can be used only if approved by the CM. Refer Attachment C.
  - 6.2.16.2 The front splitter/undertray must be:
    - flat and not stepped or curved;
    - mounted in its factory location;
    - no lower than the straight line prescribed between the bottom of the chassis rails and the front cross member lower section; and
    - no higher than 19 mm above the straight line prescribed between the bottom of the chassis rails and the front cross member lower section.

A variation of a maximum of 13 mm (rake) is permitted from the front leading edge (at 0) to the rear trailing edge of the splitter/undertray (at 13 mm). Wear strips are not considered when measuring splitter/undertray height.
- 6.2.17 Any splitter/undertray must be no longer than 625 mm deep and must follow without protruding past the profile and of the further most point of the front bumper and air dam. Refer to Attachment C.
- 6.2.18 The splitter/undertray thickness must be no thicker than 9 mm and no thinner than 6 mm.
- 6.2.19 It is permitted to affix a wear strip/s to the front underside leading edge of the one-piece fibreglass splitter. It is prohibited for the wear strip to protrude beyond the forward most profile of the front splitter. The wear strip/s must be of a polymer material with a maximum width of 50 mm and a maximum thickness of 9 mm. Refer Attachment I.
- 6.2.20 The profile of the body must remain as standard. It is prohibited to attach any additional aerodynamic aid to any section of the as standard supplied body.
- 6.2.21 Rear Wing
  - 6.2.21.1 TA2 Australia Specification Rear Wing must be fitted and remain unmodified
  - 6.2.21.2 TA2 Australia Specification Rear Wing hardware and mounts must remain unmodified.
  - 6.2.21.3 It is prohibited to fit packers and/or shims that alter the standard TA2 Australia Specification Rear Wing
  - 6.2.21.4 It is prohibited to add any aerodynamic aid on the TA2 Australia Specification Rear Wing.
  - 6.2.21.5 Standard TA2 Australia wing end plates only may be fitted.
- 6.2.22 NACA ducts or air inlet ducts may be fitted in the side rear quarter window (behind the B-Pillar) openings subject to the following:
  - 6.2.22.1 The ducts may provide air to the *Driver* or be a means of windscreen demisting only.
  - 6.2.22.2 Ducting to the engine compartment is prohibited.
  - 6.2.22.3 The placement of ducting must not impede the *Driver's* ingress or egress.
- 6.2.23 Side mirrors must be as standard and must be fitted.

- 6.2.24 Aerials and antennas may be fitted to the roof and/or boot/trunk.
- 6.2.25 Internal cameras are permitted. These must be fastened securely and must be approved by the Chief Scrutineer or their nominee.
- 6.2.26 Front and rear tow straps must be fitted and must be easily accessible and clearly marked.

## T7 INTERIOR

- 7.1 Internal panelling must remain as per original manufacturer providing that it affords the *Driver* with insulation from the engine/driveline.
- 7.2 The *Driver's Seat* must have current *FIA* certification.
- 7.3 The *Driver's Seat* must be positioned to the left of the centreline of the *Automobile*. No portion of the *Driver's* seat or restraint system may be located over the centreline of the *Automobile*.
- 7.4 The steering wheel is free.
- 7.5 It is permitted to add a steering wheel boss, which may incorporate a quick release mechanism to enable the fitment of the steering wheel.
- 7.6 The steering column must be as supplied by the original manufacturer. A collapsible column is recommended.
- 7.7 An internal rear view mirror must be fitted.
- 7.8 A *Driver's* window safety net must be fitted as original supplied by the original manufacturer.
- 7.9 Gauges and/or MoTec C125/C127 electronic dash is permitted.
- 7.10 The windscreen demisting panel vents may be modified or removed in their entirety.
- 7.11 Accelerator pedal stops may be modified to lengthen or shorten a stop by the adding or removing of thread. The original principle of the stop must be retained and the accelerator pedal travel must not be impeded.
- 7.12 Pedal pads may be modified.

## T8 SUSPENSION AND STEERING

Refer list of *Controlled Components*

### T8.1 Front Suspension

- 8.1.1 The following must remain unmodified from original manufacturer:
  - 8.1.1.1 Upper control arms;
  - 8.1.1.2 Upright (stub axle);
  - 8.1.1.3 Lower control arms;
  - 8.1.1.4 Caster bar/radius rods;
  - 8.1.1.5 *Chassis* suspension mounts (+/- 3 mm); and
  - 8.1.1.6 Sway bar and linkages/fittings.
- 8.1.2 Howe Spec shims are permitted to be added to the top arm for the purpose of alignment and the factory bolt length must be retained. A minimum of one thread must protrude through the locking nut of a top arm bolt.
- 8.1.3 The "Penske 7500 Series" shock absorber only is permitted.
  - 8.1.3.1 The shock absorber and its valving are a *Controlled Component*.

- 8.1.3.2 Only a 2024 specification shock absorber supplied by TA2 Australia or that has been re-valved by an Authorised TA2 Shock Repair Centre (ATSRC) is permitted. A shock absorber must only be serviced by an ATSRC listed in Attachment K.
- 8.1.3.3 Additional external method/s of adjusting bump or rebound characteristics are prohibited and any other modification is prohibited.
- 8.1.3.4 External nitrogen canisters are prohibited.
- 8.1.3.5 There is an allowance for coil over adjusting sleeves (silicone hose that fits over the coil over body threaded section and secured via hose clamp to prevent the adjuster from rotating). The sole purpose of this sleeve is to reduce the damage to the coil over body threaded section from the adjuster ring locking screw.
- 8.1.4 Coil springs must be located in the original manufacturer position. The permitted spring rate range is 350 to 750 lb. Helper springs are permitted. For each Practice session only, it is permitted to use a coil over spring rubber insert.
- 8.1.5 Heim joints are free.
- 8.1.6 Upper and lower ball joints must be Howe PBR specification.
- 8.1.7 Bump stops and extension limiters are prohibited.
- 8.1.8 It is prohibited to disconnect or modify the front sway bar or its mountings or linkages.
- 8.1.9 Front ride height is a minimum of 65 mm measured at the *Chassis* location in accordance with Attachment D. Minimum tyre pressure for ride height measurement is 20 psi (138 kPa). Maximum tyre pressure is the highest tyre pressure recorded in any tyre as fitted to that *Automobile* at the time of a technical check as conducted by the *TD* or their delegate. This maximum tyre pressure will be as determined by the *TD*.
- 8.1.10 Minimum thread engagement of the Heim joints into the caster bar/radius rod must be no less than one time of the nominal diameter (approximately 10 threads) of thread engagement into the bar at both ends.

## **T8.2 Rear Suspension**

- 8.2.1 Rear axle location and mounting must remain unmodified from the original manufacturer.
- 8.2.2 Rear axle housing must remain unmodified from original manufacturer.
- 8.2.3 Upper and lower trailing arms must be steel.
- 8.2.4 Watts Linkage mechanisms must remain unmodified from original manufacturer.
- 8.2.5 Pinion angle is free within the permitted range of the associated *Controlled Components*.
- 8.2.6 The "Penske 7500 Series" shock absorber only is permitted.
  - 8.2.6.1 The shock absorber and its valving are a *Controlled Component*.
  - 8.2.6.2 Only a 2024 specification shock absorber supplied by TA2 Australia or that has been re-valved by an Authorised TA2 Shock Repair Centre (ATSRC) is permitted. A shock absorber must only be serviced by an ATSRC listed in Attachment K.
- 8.2.7 Coil springs must be located in the original manufacturer position. The permitted spring rate range is 200 to 500 lb. Helper springs are permitted. For each Practice session only, it is permitted to use a coil over spring rubber insert.
- 8.2.8 A maximum of 3 mm total camber is permitted (+/- vertical).
- 8.2.9 A maximum of 3 mm total of toe is permitted (+/- horizontal).
- 8.2.10 Bump stops and extension limiters are prohibited.

- 8.2.11 Rear ride height is a minimum of 65 mm measured at the *Chassis* location in accordance with Attachment D. Minimum tyre pressure for ride height measurement is 20 psi (138 kPa). Maximum tyre pressure is the highest tyre pressure recorded in any tyre as fitted to that *Automobile* at the time of a technical check as conducted by the *TD* or their delegate. This maximum tyre pressure will be as determined by the *TD*.
- 8.2.12 It is permitted to disconnect or remove the rear sway bar. If disconnected it must be secured so as not to interact with any other component.

### **T8.3 Steering**

- 8.3.1 The Woodward 18.25" steering rack only is permitted.
- 8.3.2 The steering link arms must be aluminium. Welding or jointing is prohibited.
- 8.3.3 The power steering pump must be belt driven from the front of the crankshaft.
- 8.3.4 Power steering fittings and lines are free.
- 8.3.5 Power steering cooler must be fitted in accordance with manufacturer or *Controlled Components* supplier requirements.

## **T9 BRAKES**

Refer list of *Controlled Components* and *Optional Components*

- 9.1 The brake components fitted to the *Automobile* must remain the same specifications to those *Controlled Components* or *Optional Components*.
- 9.2 [A single strip and layer of tape of a maximum of 51 mm wide may be applied to the bottom of the brake duct box openings. Otherwise](#) brake duct box openings are to remain as standard and in factory positions.
- 9.3 Mustang/Camaro: 255 mm +/- 5 mm wide, 120 mm +/- 5 mm high
- 9.4 Dodge: 210 mm +/- 5 mm wide, 120 +/- 5 mm high and 255 mm diagonally from bottom to top corners.
- 9.5 Relocation of the brake duct grille mesh from the front of the duct to the middle of the duct is permitted. [Brake duct grille mesh must be steel or stainless-steel material with a consistent mesh weave and aperture type. Only one layer and type of mesh is permitted.](#)
- 9.6 Caliper spacers are prohibited.
- 9.7 Cutting or modifying of the brake pad is prohibited.
- 9.8 Brake bias adjuster must remain in original location.
- 9.9 Brake line material and size is free.
- 9.10 All four-wheel brakes must always be operational.
- 9.11 Line lock devices are prohibited.
- 9.12 Bracing or modification of caliper mounts, front or rear, is prohibited.
- 9.13 Brake bias gauges are free.
- 9.14 Removal of brake fans is permitted.
- 9.15 It is permitted to remove material from a brake bobbin to ensure correct clearance fit.

## **T10 WHEELS AND TYRES**

- 10.1 Each *Automobile* must use the *Controlled Component* wheel.
- 10.2 Wheels may be coated, painted or chromed.



- 10.3 Each wheel must be clearly marked on the outside face of the wheel rim with the *Automobile's Competition Number*.
- 10.4 Steel wheel nuts must be used.
- 10.5 Each tyre must be in compliance with the 2024 Trico Trans Am Series Sporting Regulations.

## T11 ENGINE

- 11.1 Only the "PBR" LS3 based engine is permitted. Refer Engine Specification Sheet available from the *CM*.
- 11.2 Each engine must be fitted with "PBR" engine *Seals*.
- 11.3 An engine change is only permitted with the written approval of the *TD*.
- 11.4 Unless specified in these regulations, modification of the components of the engine are prohibited.
- 11.5 The fuel pump must remain the original type, mounting position and unmodified. Filter elements are permitted.
- 11.6 The airbox and air filter location must remain unchanged. All engine air intake must pass by the air filter and throttle body. Any other inlet air to the engine is prohibited.
- 11.7 Rocker cover type and design is free.
- 11.8 The water pump must be belt driven from the front of the crankshaft.
- 11.9 The control *ECM* unit must be used.
- 11.10 The starter motor position must remain unchanged from the original manufacturer position.
- 11.11 Spark plugs and spark plug leads are free.
- 11.12 Coolant pipes must be as per original manufacturer.
- 11.13 Radiator and oil cooler type and position must be as per original manufacturer.
- 11.14 Thermo fans are permitted.
- 11.15 It is permitted to install a radiator protection screen mounted directly to and in front of the radiator. The screen is to be of NOMEX honeycomb material and must only cover the radiator core with a maximum thickness of 13 mm.

## T12 TRANSMISSION AND DRIVETRAIN

- 12.1 Original supply Gearbox ratios must be:
  - 12.1.1 1<sup>st</sup> gear: 1.933:1
  - 12.1.2 2<sup>nd</sup> gear: 1.450:1
  - 12.1.3 3<sup>rd</sup> gear: 1.712:1
  - 12.1.4 4<sup>th</sup> gear: 1.00:1
- Optional Components* Gearbox ratios must be:
  - 12.1.5 1<sup>st</sup> gear: 1.933:1
  - 12.1.6 2<sup>nd</sup> gear: 1.440:1
  - 12.1.7 3<sup>rd</sup> gear: 1.154:1
  - 12.1.8 4<sup>th</sup> gear: 1.00:1
- 12.2 The shift lever is free.

- 12.3 The shift operation must retain the original “H” pattern. Operation of the gearbox must be exclusively manual, with gear selection effected by only the *Driver* to the exclusion of all automatic and semi-automatic mechanisms.
- 12.4 The gearbox must retain an operational reverse gear.
- 12.5 Clutch and pressure plate must be of single plate design of the same size as the original (290 mm).
- 12.6 Clutch operation must be via internal slave cylinder.
- 12.7 Clutch master cylinder must remain as standard.
- 12.8 The tailshaft assembly must be of one-piece construction 40” long and of steel material. Yoke material is free.
- 12.9 Axles must remain unmodified from original manufacturer.
- 12.10 Final drive ratio must be 4.11:1. Secondary gear set is free.
- 12.11 Camber or toe adjustable hubs are prohibited.
- 12.12 Adjusting of rear wheel camber is prohibited.
- 12.13 Transmission and drivetrain coolers must be fitted in accordance with manufacturer or *Controlled Components* supplier requirements.

## T13 ELECTRICAL & IGNITION SYSTEM

- 13.1 The battery must be a 12 volt dry cell type and must remain within 50 mm of its original location.
- 13.2 The wiring loom must be as specified by the *CM* and remain unmodified from original manufacturer.
- 13.3 The wiring loom to the *ECM* must be as specified by the *CM* and remain unmodified from the original manufacturer.
- 13.4 Any modification to the *ECM* and wiring loom is prohibited.
- 13.5 CPWS spec MoTec overlay loom must remain as supplied without modification.
- 13.6 Data logging is only permitted through the MoTec Dash, MoTec Camera, or any other camera system and is limited to GPS speed, engine RPM, engine oil and fuel pressure, engine water and engine oil temperature, throttle position, lap time and brake pressure sensors. Additional data channels and or data expander modules are prohibited.
- 13.7 An engine crankshaft belt driven alternator must be fitted and remain operational at all times.
- 13.8 The *ECM* must be as specified by the *CM*, remain unmodified from the original manufacturer, and be fitted with the original manufacturer *Seal*. An *ECM* change is only permitted with the written approval of the *TD*.
- 13.9 Electrical equipment fitted to an *Automobile* must include:
  - 13.9.1 stop lights;
  - 13.9.2 engine starting system;
  - 13.9.3 windscreen wipers; and
  - 13.9.4 a rain light in accordance with the Technical Appendix - *Schedule C*.
- 13.10 The master switch, located to the left-hand side of the steering wheel, must be fitted and operate as specified by the *CM*. This master switch location must be clearly marked by a symbol, showing a red spark in a white edged blue triangle of minimum edge length 150 mm, which is fitted forward on the driver door. The master switch itself must be identified by a bright colour (i.e. red/yellow).

- 13.11 The category timing device (e.g. Dorian), as required for each *Round*, must be fitted to each *Automobile* in accordance with Attachment J.

## T14 FUEL AND FUEL SYSTEM

- 14.1 Fuel must be in accordance with the 2024 Trico Trans Am Series Sporting Regulations.
- 14.2 Fuel pumps must remain the type specified by the *CM*, remain unmodified and mounted in the original position.
- 14.3 The fuel cell must be FIA approved (FT3 Spec). Capacity must be 84 litres/22 gallons. A fuel check valve must be fitted.
- 14.4 The use of the fuel sample valve is mandatory.

## T15 FIRE EXTINGUISHER SYSTEM

It is mandatory that each *Automobile* be fitted with the *CM* approved on-board fire extinguisher and activation system. Each extinguisher fitted must remain compliant with the relevant extinguisher system standard (i.e. SFI 17.1 On Board Fire Suppression Systems) including any necessary service requirements.

## T16 IN-CAR CAMERAS

- 16.1 Each *Automobile* must be fitted with a complete in-car camera system as specified by the *CM*.
- 16.2 Subject to approval of the *CM*, it is permitted to fit additional cameras including those that utilise GPS systems.
- 16.3 Unless the camera or remote lens has been installed by the *CM* or by the *Series* telecaster, it is prohibited for any camera or remote lens to be fitted outside the *Cockpit*.
- 16.4 Any *Competitor* installed camera must not interfere with the vision or operation of any camera installed by the *CM* or the *Series* telecaster.
- 16.5 The fitting of each camera must be approved by the Chief Scrutineer (or their nominee) prior to the *Automobile* proceeding on to the *Track*.

## ATTACHMENT B

### Suspension setup

3 Link Chassis Mount – The use of the bottom (lower) hole is prohibited.

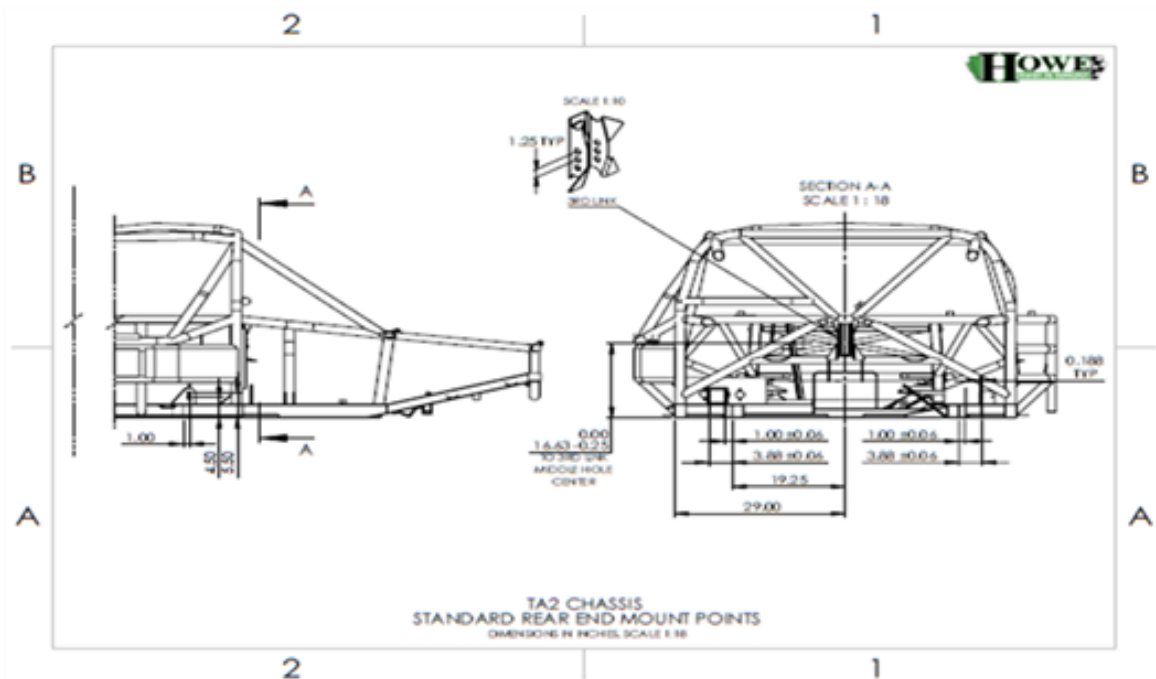

## ATTACHMENT C

### Front Splitter Details

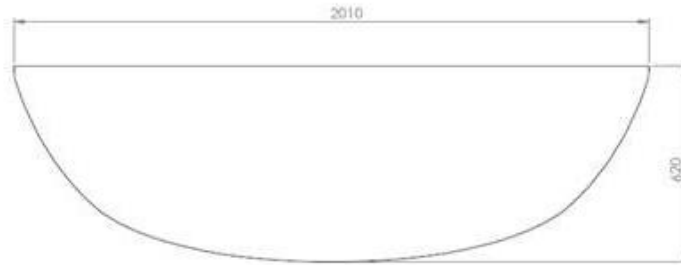

### Camaro and Mustang



### Dodge

## ATTACHMENT D

### Front ride height measurement location

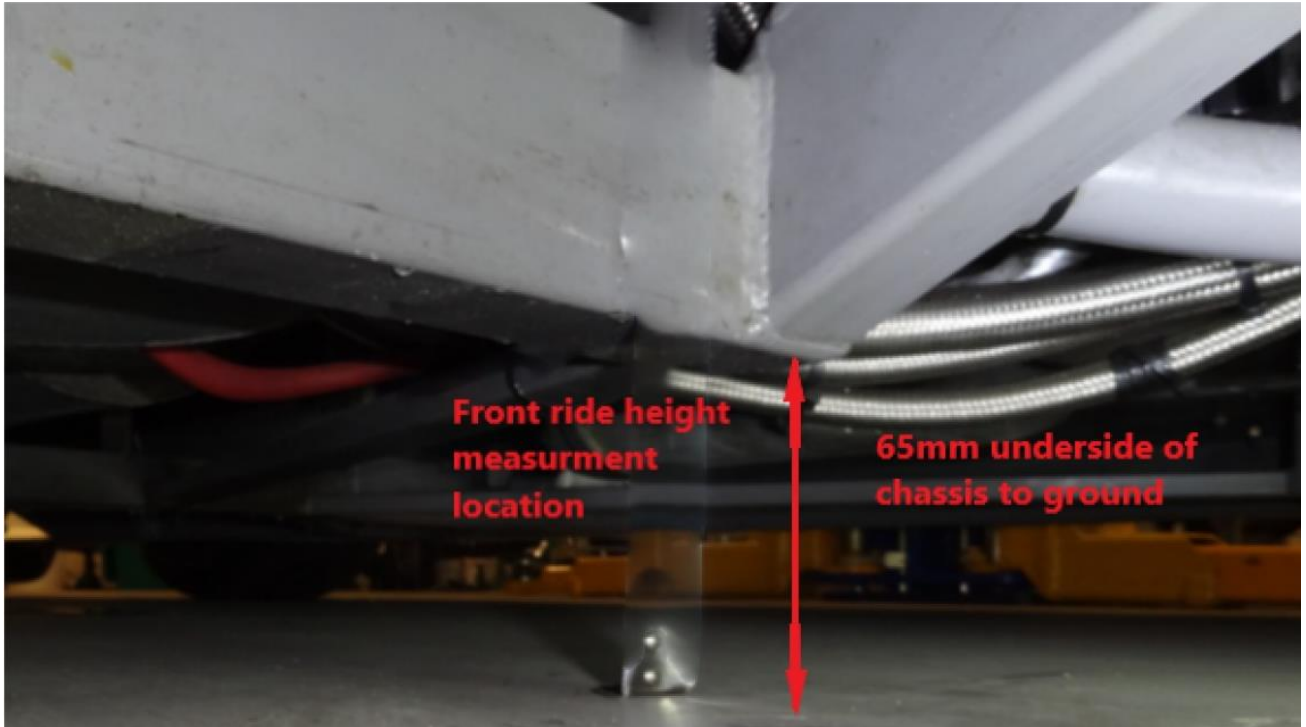

## ATTACHMENT E

### Rear ride height measurement location

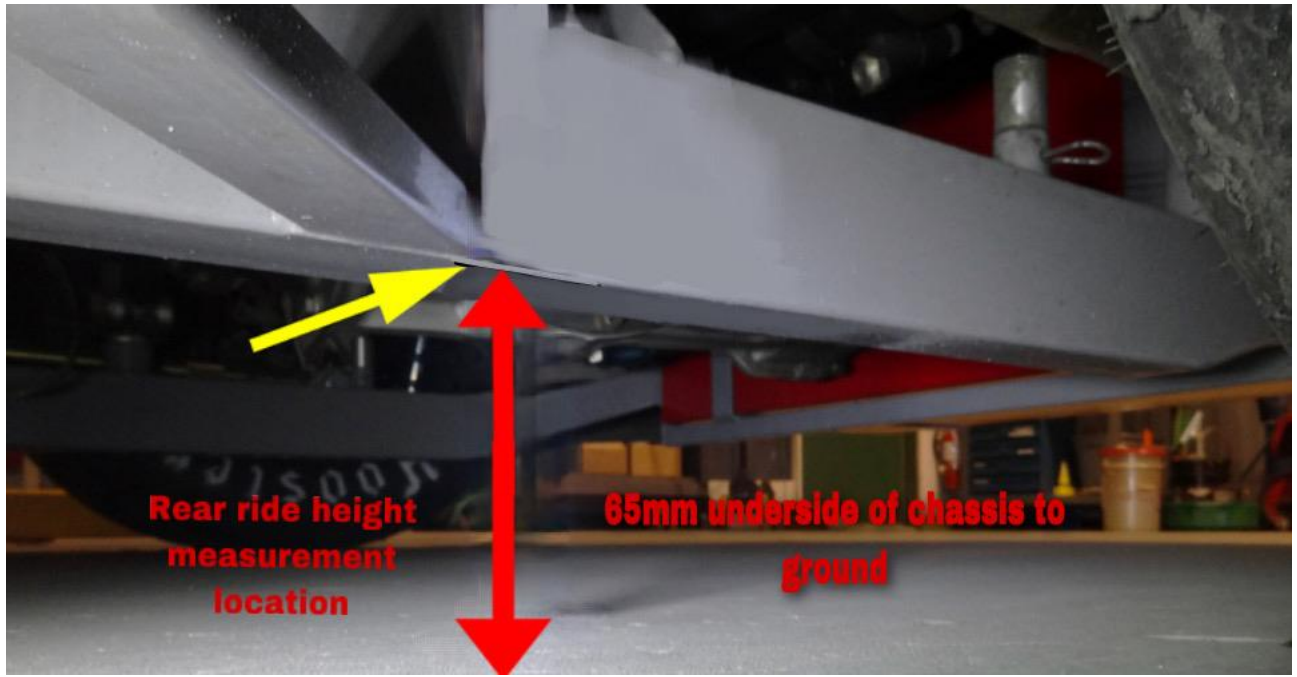

# ATTACHMENT F

## Dodge grille

Job #   Qty Read   Read By   Qty Come   Additional Processing YES <input type="checkbox"/> NO <input type="checkbox"/> Notes :		Setup Time        min    Total Time        hr Cycle Time        sec    Machine        min
---	--	--

  

	KILLNER'S ENGINEERING 41 Sackville Street, Bulimba, QLD 4171 Ph: +61 07 3099 4272 Fax: +61 07 3099 1210	SCALE DRAWN CHECKED APPROVED CLIENT CRD CLIENT APPD ASSY NO.	SIGNED DATE	CLIENT STREET ELITE RESTORATIONS	TITLE AIR GRILL	DRAWING NO. SHEET NO.    REV
--	---	--	----------------	-------------------------------------	--------------------	---------------------------------

Product ID	Material   1.6 MM ALI	Parts / m	Weight
------------	-----------------------	-----------	--------

### Grille opening locations



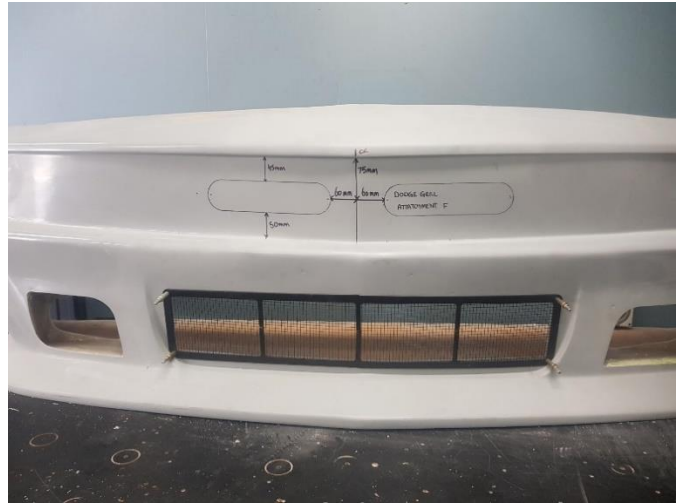
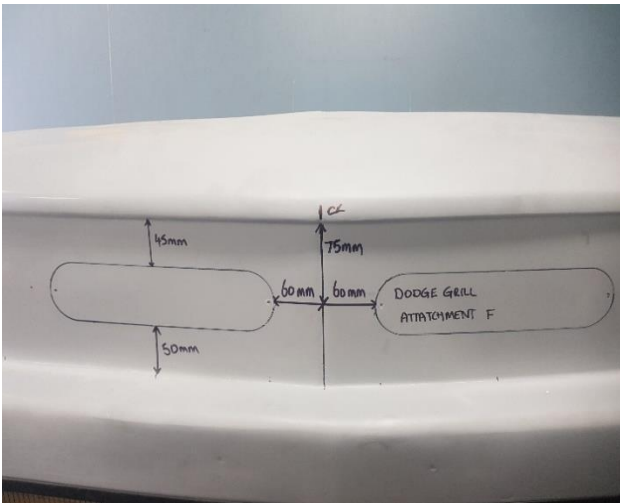

## ATTACHMENT G

### Camaro grille

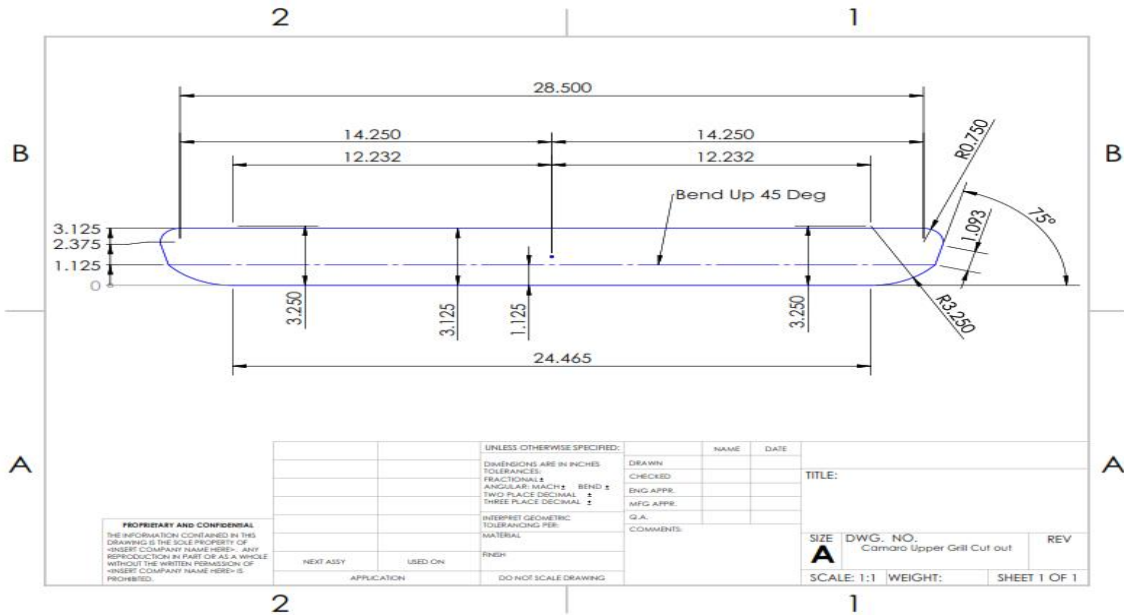

### Grille opening locations

It is recommended to maintain a 100 mm wide bridge section in the middle of the cut out.

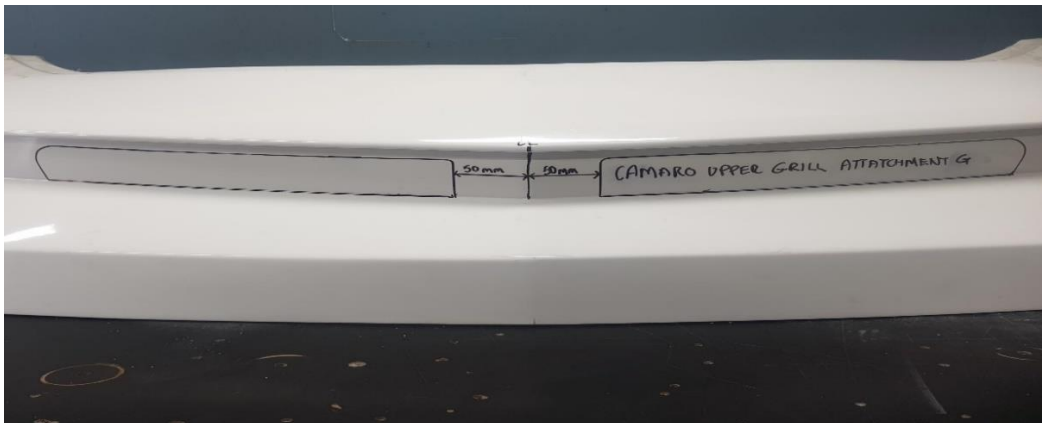
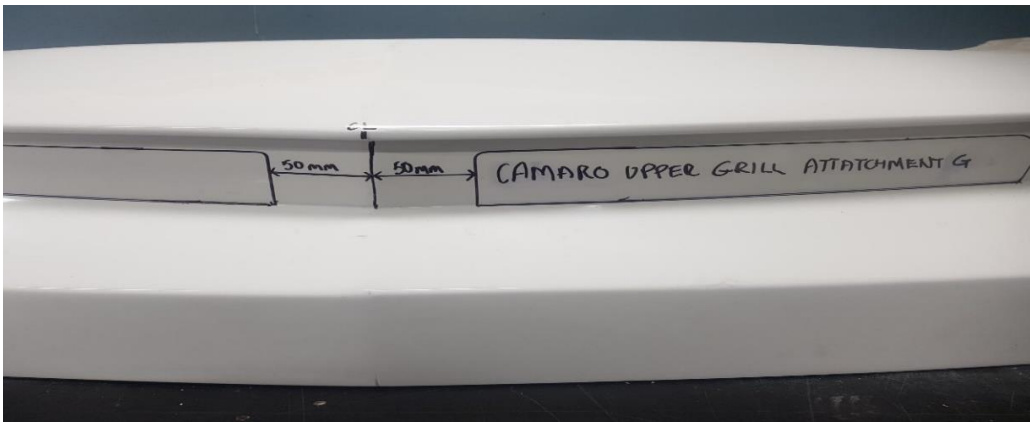

# ATTACHMENT H

## Mustang grille

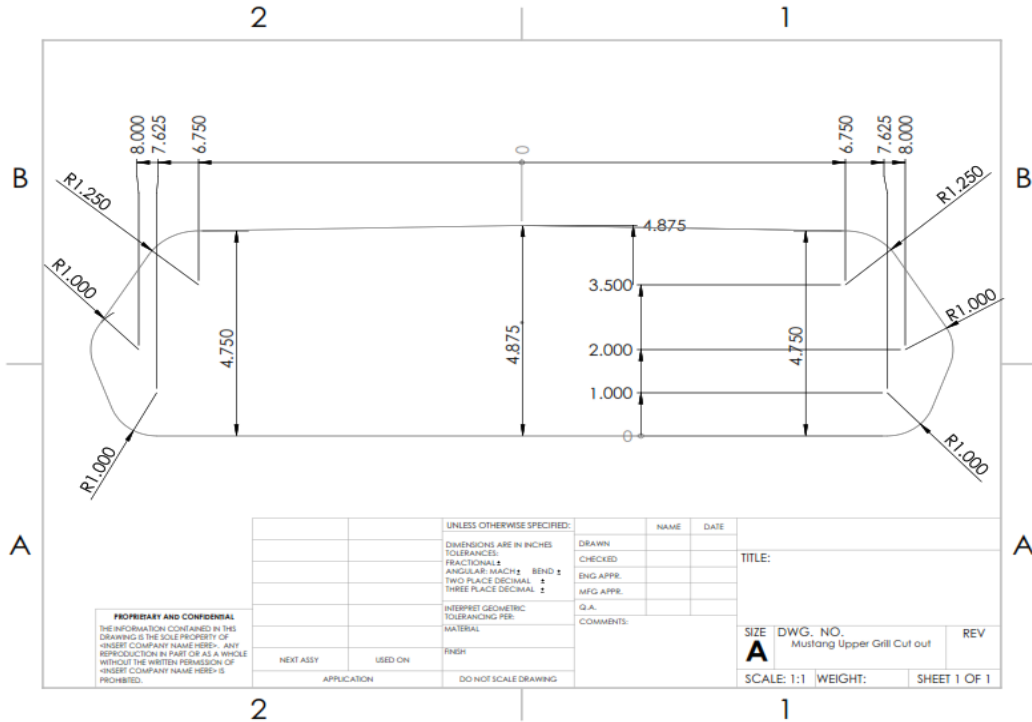

## Grille opening locations

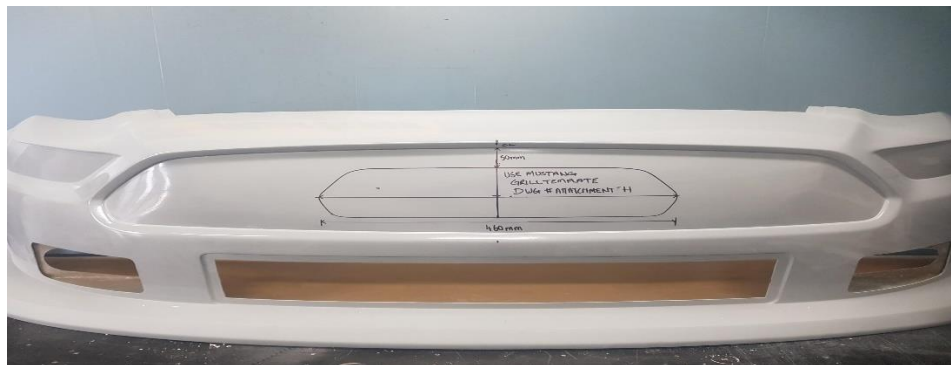
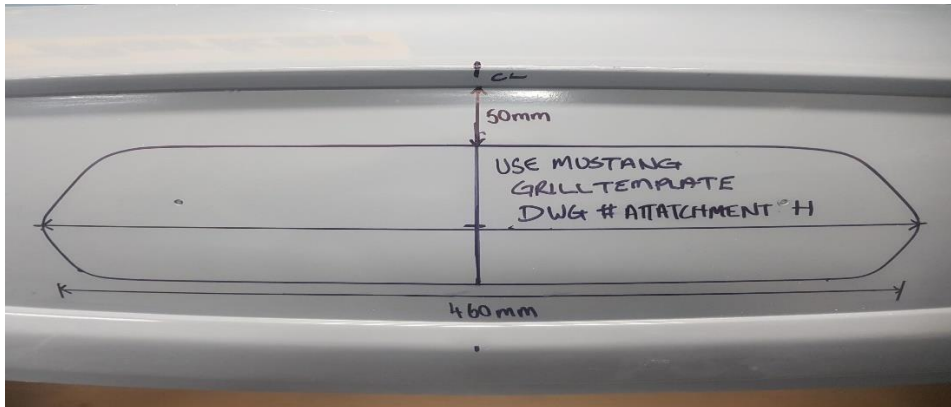

## ATTACHMENT I

### One-piece fibreglass splitter – Wear strip

#### EXAMPLE

Refer to Article T4 *Optional Components* for wear strip Part Numbers



## ATTACHMENT J

### Timing device fitment location

The timing device must be fitted on the *Driver's* side, on the inner surface of the outer chassis rail.



## ATTACHMENT K

### Authorised TA2 Shock Repair Centres (ATSRC)

NSW	Waltec Motorsport	Aaron Tebb	0433 088 320
NSW	DNA Autosport	Andre Nader	(07) 9787 9900
QLD	PBR Distributions	Cam Sendall	(07) 3800 0141
VIC	Advanced Vehicle Design	Les Small	0418 314 062
VIC	Racing Shocks Australia	Rob Palermo	0407 951 990
VIC	Garry Rogers Motorsport	Stefan Millard	(03) 9793 6933
WA	Racin Tyres & Accessories	Craig Vosbergen	0419 953 800

## ATTACHMENT L

### Definitions

**Authorised Series:** A National Series authorised by *Motorsport Australia*.

**CA:** Category Administrator for the *Series* appointed by the *CM*.

**CM:** Category Manager for the *Series* appointed by *Motorsport Australia*.

**Competition Number:** The number used to identify each *Automobile* and as displayed on the *Automobile* in accordance with the *Series* Sporting Regulations.

**Controlled Component:** A component listed in the *Series* Technical Regulations that must be fitted to an *Automobile*.

**CRSR:** Circuit Race Standing Regulations published by *Motorsport Australia*.

**DSA:** Driving Standards Advisor for the *Series* appointed by *Motorsport Australia*.

**ECM:** Electronic Control Module.

**Optional Component:** A component listed in the *Series* Technical Regulations that a *Competitor* may choose to fit to an *Automobile*.

**RD:** Race Director for the *Series* appointed by *Motorsport Australia*.

**RMC:** Race Management Channel.

**Round:** A round of the *Series*.

**Series:** The 2024 Trico Trans Am Series.

**TA:** Technical Advisor for the *Series* appointed by the *CM*.

**TD:** Technical Delegate for the *Series* appointed by *Motorsport Australia*.

**Team Manager:** Authorised representative of the *Competitor* other than the *Driver*.