

Modified Article	Date of Application	Date of Publication
4.1(d)	01/01/2025	01/01/2025
16 (d)	01/01/2025	01/01/2025
J-47, J48, J-49, J50, J53, J56, J57.	01/01/2025	01/01/2025

A capitalised and italicised word in this document is defined in the FIA International Sporting Code (Code) or the National Competition Rules (NCR), including their Appendices.

Any HEADING is for reference only and has no regulatory effect.

Contents

Article	Title	Page
1	General	1
2	Definitions	2
3	Application (<i>Competition</i> in which a safety cage structure is required)	3
4	Safety Cages Built to Previous & Overseas Regulations	4
5	Registration (documenting a standard safety cage structure)	5
6	Certification by <i>Motorsport Australia</i> (approval process for a safety cage structure with acceptable variations)	6
7	Non-Complying Safety Cage Structures (provisions when a safety cage structure is not required)	6
8	Material Specifications	6
9	Bending	8
10	Guidance on Welding	8
11	Protective Padding	8
12	Specifications – Closed Sports & Touring Cars	9
13	Specifications – Open and Closed Cars Type 2 Cage	13
14	Specifications – Single Seat Cars	14
15	Reinforcement of Bends and Junctions	16
16	Removable Members	17
17	Additional Constraints	17
18	Mounting of the Safety Cage Structure to the Bodyshell/Chassis	18

1. GENERAL

- (a) Where the fitting of a safety cage structure is specified, it shall be constructed and installed in accordance with this Schedule.
- (b) Any repair to a safety cage structure shall comply with the requirements applicable at the time of original manufacture.
- (c) Any modification to a homologated or certified safety cage is forbidden without the express permission of *Motorsport Australia*. In the case of an *FIA* homologated or *Motorsport Australia* certified safety cage structure any repair shall be carried out by the manufacturer or with the manufacturer's approval. The repaired safety cage shall remain in compliance with the homologation VO or certificate.
- (d) Any tube forming part of a safety cage structure shall not carry fluids or any other materials.
- (e) The safety cage structure shall not unduly impede the entry or exit of the driver/crew.
- (f) Unless category regulations permit, complete parts of upholstery or trim shall not be removed, however the interior trim and dashboard may be modified locally (e.g. by cutting or distorting) in order to fit a safety cage structure. A rear seat may be folded down. A fuse box may be relocated to enable a safety cage structure to be fitted.
- (g) Supplementary Regulations may impose more stringent requirements than those specified in this Schedule.
- (h) If an *Automobile* is to incorporate a carbon fibre survival cell technology, refer to *Motorsport Australia* Technical Department for advice prior to purchase or building.

2. DEFINITIONS



TYPE 1

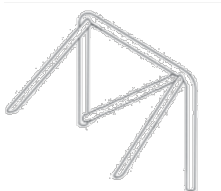

TYPE 2

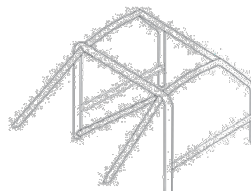

TYPE 3

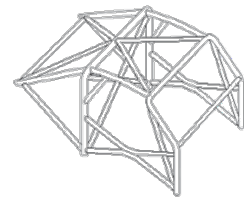

TYPE 3

2.1 SAFETY CAGE STRUCTURE:

Multi-tubular structure installed in the cockpit and fitted close to the bodyshell, the function of which is to reduce the deformation of the bodyshell (chassis) in case of an impact.

2.2 ROLL BAR:

A tubular frame with two mounting feet, forming a hoop.

2.3 MAIN ROLL BAR (DRAWINGS J-2 AND J-3):

A transversal and near-vertical (maximum angle $\pm 10^\circ$ to the vertical) single piece hoop located across the *Automobile* and immediately behind the front seat/s. The tube axis shall be within a single plane.

2.4 FRONT ROLL BAR (DRAWING J-3):

A roll bar, the shape of which follows the pillars and upper edge of the windscreen (where fitted).

2.5 LATERAL ROLL BAR (DRAWING J-4):

A near-longitudinal single piece hoop located along one side of the *Automobile*, the rear pillar part of which is near-vertical (maximum angle $\pm 10^\circ$ to the vertical) and straight in side view and located immediately behind the front seat/s, and the front part of which follows the windscreen pillar. Drawing J-4 may be replaced with that of drawing J-4b.

2.6 LATERAL HALF ROLL BAR (DRAWING J-2):

Similar to the lateral roll bar but without the vertical rear leg. Also referred to as a 'front leg'.

2.7 LONGITUDINAL MEMBER (DRAWING J-3):

A near-longitudinal tube joining the upper parts of the front and main roll bars.

2.8 TRANSVERSAL MEMBER (DRAWING J-4):

A transversal tube joining the lateral roll bars or backstays.

2.9 DIAGONAL MEMBER (DRAWINGS J-5 TO J-9):

A tube between a top corner of the main roll bar, or (in the case of a lateral roll bar) one end of the transversal member, and the lower mounting point of the roll bar on the opposite side or between the upper end of a backstay and the lower mounting point of the other backstay.

2.10 REMOVABLE MEMBER:

A member of a safety cage structure which can be removed by unbolting.

2.11 CAGE REINFORCEMENT:

A member added to the safety cage structure to improve its strength.

2.12 MOUNTING FOOT:

A plate welded to the end of a roll bar tube or member to enable it to be bolted and/or welded to the bodyshell/chassis.

2.13 REINFORCEMENT PLATE:

A plate attached to the bodyshell/chassis to support a mounting foot.

2.14 BACKSTAY (DRAWING J-3 AND J-4):

A straight and near-longitudinal member located rearward between the top of the main or lateral roll bar, and the bodyshell/chassis.

2.15 GUSSET (DRAWING J-1):

A reinforcement, made from sheet steel of not less than 1.0mm thick, formed to a U-shape and welded to a bend or junction. The dimension (L) shall be between two and four times the diameter of the larger of the tubes joined.

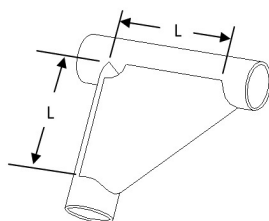

DRAWING J-1

3. APPLICATION

A safety cage structure complying with Schedule J is required as follows:

3.1 RACES (INCLUDES PRACTICE, QUALIFYING AND WARM-UP):

- (a) **Contemporary:** Each *Automobile* other than a closed, road-registered *Automobile* participating in a Club or Multi-Club level race.
- (b) **Historic (5th Category):** Each *Automobile* in a race exclusively for the 5th Category shall be fitted with a safety cage structure as required by the 5th Category Historic Technical Regulations and, where applicable, these regulations.

3.2 SPEED AND REGULARITY EVENTS:

- (a) Each 1st Category *Automobile* in a Speed or Regularity *Event*.
- (b) State Championship and above level Speed *Event* and Regularity *Event*, other than:
 - (i) a *Automobile* of the 5th Category (unless otherwise specified in the Historic Technical Regulations); or
 - (ii) a *Automobile* which is road registered.

3.3 OFF ROAD EVENTS:

- (a) Each Performance 2WD, Extreme 2WD, Production 4WD, Extreme 4WD and Side by Side (SXS) *Automobile* in an Off Road *Event*.
- (b) Each Extreme 2WD and Extreme 4WD may alternatively comply with the prescriptions of GR9 of Off Road – General Requirements for Off Road Vehicles.
- (c) Each SXS *Automobile* shall be approved by *Motorsport Australia* based on the criteria for a Type 3 safety cage in this schedule.

Each buggy - Pro, Prolite, Sportslite, Super 1650, Sportsman and Clubman class *Automobile* shall comply with the prescriptions of GR9 of Off Road – General Requirements for Off Road Vehicles.

3.4 RALLY/ROAD EVENTS:

- (a) Special Stage Rallies: Each *Automobile*, other than:
 - (i) for a closed *Automobile* in a Club or Multi-Club Stage 1 Rallyprint; or
 - (ii) for a 5th Category Historic Car entered in a rally, unless the *Automobile* is required to be fitted with a safety cage structure when entered in a 5th Category, Historic-only circuit race. The safety cage structure fitted shall be to at least the same specification as required in a race. This provision shall apply only to a *Automobile* subject of and which remains in conformity with, a 5th Category Certificate of Description. This exception does not apply to Historic Touring Cars (Group N) or Historic Production Sports Cars (Group S).
- (b) Speed Limited Special Stage Rallies (as per relevant *Event* regulations): a minimum of a Type 2 safety cage structure incorporating requirements for *Competition* with more than one occupant.
- (c) Exceptions: A safety cage structure is not mandatory in:
 - (i) Touring Event except where required as per NRSR TE (i.e. Closed Road Special Tests);
 - (ii) a Touring Assembly;
 - (iii) a Navigation Assembly; or
 - (iv) a road *Event* conducted entirely in compliance with the normal civil road regulations. Note: as an example, this exemption does not apply to an *Event* where elements of the *Competition* allow the statutory speed limit to be exceeded.

3.5 NON-SPEED EVENT (I.E. MOTORKHANA, KHANACROSS AND OBSERVED SECTION TRIALS):

As specified under the Auto Test section of the Manual.

3.6 DRIFTING:

As specified in the Drifting Standing Regulations. A safety cage structure is mandatory in each open *Automobile*.

3.7 INTERNATIONAL EVENTS:

As specified by the *FIA*. The *Competitor* should note additional or different requirements to Schedule J may apply.

3.8 OTHER EVENTS AND ADDITIONAL REQUIREMENTS:

As specified in the *Supplementary Regulations*.

4. SAFETY CAGE STRUCTURES BUILT TO PREVIOUS AND FOREIGN REGULATIONS

4.1 AUTOMOBILES BUILT TO PREVIOUS MOTORSPORT AUSTRALIA REGULATIONS:

Where a safety cage structure is fitted to a *Automobile* which is subject of a *Motorsport Australia* log book, or where the safety cage structure has been registered or certified by *Motorsport Australia*, such safety cage structure may continue to be used in *Competition* provided it remains in conformity with the regulations that were in force at the date of issue of either the initial log book for the *Automobile*, or the registration/certification document.

Regardless of when the car was first subject of a log book, the following requirements apply

- (a) a Type 3 Full Safety Cage structure is the minimum requirement in a closed *Automobile* in a national or state level race, except in *Competition* exclusively for the 5th Category (and unless otherwise specified in the relevant Historic Technical Regulations);
- (b) a Type 3 Full Safety Cage structure is the minimum requirement in a closed *Automobile* in a national level rally, ~~and/or a Tarmac Rally;~~
- (c) a Type 3 Full Safety Cage structure with a roof reinforcement configuration complying with Drawing J-14, J-15 or J-16 is the minimum requirement in an open *Automobile* in a timed rally/trial or off road *Event*;
- (d) Unless specified in group or category technical regulations, only a safety cage manufactured from materials detailed in Articles 8.4 and 8.5 are permitted for:
 - (i) Each *Automobile* in a National level Race, Rally or Off Road *Competition* – Effective from 01/01/2025
 - (ii) Each *Automobile* in a Race, Rally or Off Road *Competition* – Effective from 01/01/2026

- (e) protective padding is required in accordance with Article 11.
- (f) It is permitted to add non-compulsory bars to a safety cage structure.
 - (i) This shall not affect the original registration of the structure.
 - (ii) Where a non-compulsory bar is added it shall be attached as specified in these regulations. This shall include material specifications as listed (Table J-1 and J-2).
 - (iii) Any addition to a registered safety cage shall be submitted to *Motorsport Australia*, with the *Automobile* logbook for approval and update.
 - (iv) For a certified safety cage, an addendum must be submitted to *Motorsport Australia* for approval prior to fitment of any non-compulsory member.

4.2 FOREIGN AUTOMOBILES NOT COMPLYING WITH SCHEDULE J:

- (a) A safety cage structure approved by an ASN other than *Motorsport Australia* is not necessarily eligible for *Competition* in Australia. Prior to importing an *Automobile*, a *Competitor* is strongly advised to contact the *Motorsport Australia* Technical Department for guidance.
- (b) *Motorsport Australia* may accept a *Automobile* recognised by Motorsport New Zealand (MSNZ) fitted with a safety cage structure not complying with Schedule J. The safety cage must comply with Schedule J in all respects except for:
 - (i) the main roll bar tubing, the minimum size of which is 38.1mm x 2.5mm; and/or
 - (ii) the use of ERW tubing to MSNZ specification.

In each case:

- (i) the *Automobile* must be subject of a MSNZ log book;
- (ii) the safety cage structure must be subject of a MSNZ safety cage structure homologation document;
- (iii) the *Automobile* must have been used in a rally or race *Competition* in New Zealand, evidenced by a valid entry in the log book; and
- (iv) where the dimension of the main roll bar tubing is less than 44.45mm x 2.5mm, the safety cage structure shall incorporate a double diagonal (cross) configuration in the main roll bar in accordance with Drawing J-7.

NOTE: A *Automobile* with a 38.1mm diameter main roll bar shall be acceptable only if the MSNZ log book was issued prior to 1 January 2011. This aligns with MSNZ material requirements.

The documents detailed above shall be presented at scrutiny and/or upon request of the Chief Scrutineer.

A *Automobile* which is normally domiciled and/or is road registered in New Zealand is permitted to compete in rallies in Australia for a maximum period of three calendar months without being required to comply with (iv) of this article, provided that the *Automobile* complies with MSNZ safety cage regulations. Thereafter the *Automobile* must either comply fully with the requirements of Schedule J or be exported from Australia before any further dispensation can be considered.

4.3 SAFETY CAGE KITS:

- (a) Despite some manufacturers' claims, not every safety cage structure built from a commercially available 'kit' complies with the current *FIA* and/or *Motorsport Australia* regulations.
- (b) A *Competitor* proposing to install such a kit is strongly advised to contact the *Motorsport Australia* Technical Department for guidance prior to purchasing.

5. REGISTRATION

- (a) A registered safety cage structure is one which has been accepted by *Motorsport Australia* for a specific *Automobile* on the basis of a declaration by the manufacturer that it complies with the requirements of this Schedule. This registration shall record the specification of the safety cage structure. The registration number shall be recorded in the log book.
 - (i) A safety cage registration will remain valid for a period of 2 years for the purpose of a log book application. A safety cage structure subject to a registration issued more than 2 years prior to submitting a log book application will require re-registration to comply with current regulations.
 - (ii) A safety cage registration is linked to a single *Automobile* identified by a chassis number or Vehicle Identification Number (VIN). Where a registered safety cage structure is transferred

to a different *Automobile*, the safety cage structure must be re-registered and comply with current regulations.

- (b) A safety cage structure fitted to a *Automobile* for which a log book is issued after 31 December 2000 shall be registered with *Motorsport Australia* and shall have affixed a valid *Motorsport Australia* safety cage registration label. Prior to this date, registration is not required.
- (c) Registration is not required when the type and/or status of a *Competition* does not require the use of a safety cage structure.
- (d) Registration of a safety cage structure is not evidence of its compliance with Schedule J.
- (e) A safety cage registration amendment shall be submitted to *Motorsport Australia* with the *Automobile* logbook to record an update from the original structure as detailed in Article 4.1(e).

6. CERTIFICATION BY MOTORSPORT AUSTRALIA

- (a) A certified safety cage structure is one which has been approved by *Motorsport Australia* for a specific *Automobile*, notwithstanding that it may not comply in all respects with the specifications of this Schedule.

Important note:

The certification process does not provide for 'free design' safety cage structures. It is intended primarily to prove that the manufacturer has met the strength criteria through engineering calculation despite the use of material to alternate specifications. A safety cage structure must still comply with the design criteria detailed in the applicable regulations to be eligible for certification by *Motorsport Australia*. Contact technical@motorsport.org.au for the latest information regarding certification.

- (b) Where the *Automobile* is subject of safety cage certificate, the safety cage certification number shall be recorded in the log book.
- (c) A manufacturer may apply to *Motorsport Australia* for the certification of a safety cage structure. The certification regulations are available from the *Motorsport Australia* Technical Department.
- (d) Approval in principle for any proposed design shall be sought from *Motorsport Australia* prior to commencement of construction.
- (e) A safety cage structure that is homologated/certified after 1996 shall be identified by means of an identification plate affixed to it by the manufacturer. This identification plate must not be copied or moved and shall be embedded or engraved on a metallic plate. The identification plate shall bear the name of the manufacturer, the manufacturer's unique serial number of the safety cage structure and the certification number of the *Motorsport Australia* certificate (or, where applicable, that of another ASN).
- (f) Where a safety cage structure is subject of a certificate or homologation VO, this documentation shall be presented at *Event* scrutiny and be available to the Chief Scrutineer and/or Technical Delegate upon request. The safety cage structure must comply with this document at all times.
- (g) *FIA* Certification: where an *Automobile* is intended for International *Competition* in accordance with the *Code* it must comply with the regulations as determined by the *FIA*. Any additional requirements and any associated costs must be met by the manufacturer or *Automobile* owner.

7. NON-COMPLYING SAFETY CAGE STRUCTURES

Where the type and/or status of the *Event* does not require a *Automobile* to be fitted with a safety cage structure, the use of a non-compliant structure is permitted, provided it is not deemed unsafe by the Chief Scrutineer.

8. MATERIAL SPECIFICATIONS

8.1 TUBE PROFILE:

Only tubes with a circular section are permitted.

8.2 SPORTS AND TOURING CARS:

The following shall apply to a sports or touring car:

TABLE J-1

Material	Minimum tensile strength	Minimum dimensions	Use
Cold drawn seamless (CDS) or Cold drawn welded (CDW) unalloyed carbon steel	350 N/mm ²	Metric: 44.45mm x 2.5mm or 50 x 2.0mm	Main roll bar and lateral roll bars
		Imperial: 1.75" x 0.095" or 2.0" x 0.083"	
		Metric: 38mm x 2.5mm or 40mm x 2.0mm	Lateral half roll bars and other parts of the safety cage
		Imperial: 1.5" x 0.095" or 1.6" x 0.083"	

8.3 SINGLE-SEAT AUTOMOBILES:

The following shall apply to a single-seat *Automobile* weighing 700kg or less, as defined in Article 14. For a *Automobile* that weighs over 700kg, the material specifications detailed in Article 8.2 shall apply.

350 GRADE CDW MILD STEEL TUBE
IN STOCK NOW
DELIVERY TO ALL AREAS*

*Brisbane deliveries same day in most cases

350G CDW TUBE IN STOCK:

Outside Diameter		Wall Thickness		Length	
Metric	Imperial	Metric	Imperial	Metric	Imperial
38.1mm	1" 1/2	2.6mm	0.102"	7330mm	24ft
44.45mm	1" 3/4	2.6mm	0.102"	7330mm	24ft

P: 07 3204 1000 www.metrosteel.com.au
QBCC 1190517

TABLE J-2

Material	Tensile strength	Minimum dimensions	Use
Cold drawn seamless (CDS) or Cold drawn welded (CDW) unalloyed carbon steel	350 N/mm ²	Metric: 38mm x 2.5mm or 40 x 2.0mm	Main roll bar and single brace
		Imperial: 1.5" x 0.095" or 1.6" x 0.083"	
		M: 31.7mm x 2.5mm or I: 1.25" x 0.095"	Dual braces

8.4 STEEL TYPE AND COMPOSITION:

The steel shall be cold drawn seamless (CDS) or cold drawn welded (CDW) unalloyed carbon steel containing a maximum of 0.3% of carbon, with adequate elongation and weldability properties. For an unalloyed steel, the maximum content of additives is 1.7% for manganese and 0.6% total of all other elements.

8.5 MATERIAL NOT IN COMPLIANCE:

Motorsport Australia may accept other steel materials and sizes not in compliance with this article through the process of certification.

9. BENDING

The tubing shall be bent by a cold working process and the centreline bend radius shall be at least three times the tube diameter.

If the tubing is ovalised or otherwise distorted during bending, the ratio of minor to major diameter shall be 0.9 or greater. The surface of the tube at the bend shall be smooth and even, without ripples or cracks.

10. GUIDANCE ON WELDING

- (a) Welding shall be carried out along the whole perimeter of each tube joint and shall be of the highest possible quality with full penetration, preferably using a gas-shielded arc.
- (b) Although good external appearance of a weld does not necessarily guarantee its quality, a weld of poor appearance may indicate that it is unsatisfactory.
- (c) When using heat-treated steel any special instructions of the tube manufacturer shall be followed (e.g. ambient temperature, special electrodes, gas protected welding).

11. PROTECTIVE PADDING

11.1 HELMET AND HEAD PROTECTION:

- (a) For each automobile subject of a safety cage structure where the helmet of an occupant could come into contact with the safety cage structure and/or any safety cage bar that is directly above or to the side of the helmet of an occupant, protective padding shall be fitted to that area, which complies with:
 - (i) International *Competition* and below, *FIA* standard 8857-2001, type A (see *FIA* Technical List No 23 Roll Cage Padding Homologated by the *FIA*); or
 - (ii) For National *Competition* and lower, SFI specification 45.1. For each 1st Category *Automobile*, the use of SFI specification 45.2 for the head rest is permitted.
- (b) Where it can be demonstrated that the fitment of protective padding unduly hampers the occupants' ability to operate the *Automobile* in a safe manner, the requirement for padding may be negated in the immediate area of concern at the discretion of the Chief Scrutineer.

11.2 BODY PROTECTION:

Where the body of an occupant could come into contact with the safety cage, it is recommended that flame retardant padding be fitted. *FIA* standard 8857-2001 or SFI specification 45.1 padding

12. SPECIFICATIONS – CLOSED SPORTS AND TOURING CARS (TYPE 3)

12.1 BASIC STRUCTURE:

The basic structure must be made according to one of the following designs:

1 main roll bar + 2 lateral half roll bars + 1 transversal member + 2 backstays + 6 mounting feet (Drawing J-2). This structure shall be referred to as 'Type 3 Safety Cage'.

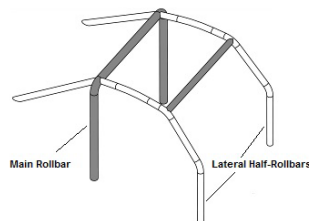

DRAWING J-2

OR

1 main roll bar + 1 front roll bar + 2 longitudinal members + 2 backstays + 6 mounting feet (Drawing J-3)

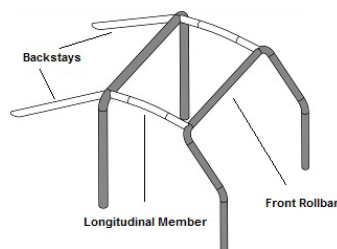

DRAWING J-3

OR

2 lateral roll bars + 2 transversal members + 2 backstays + 6 mounting feet (Drawing J-4).

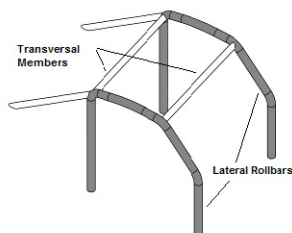

DRAWING J-4

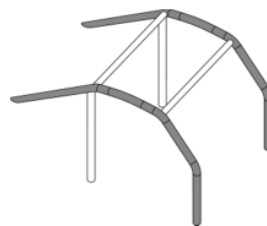

DRAWING J-4B

(a) **Main Roll Bar**

The vertical parts of the main roll bar must be as close as possible to the interior contour of the bodyshell and may have only one bend in each lower near-vertical part.

(b) **Front Roll Bar/Lateral Roll Bar**

- (i) Only one bend is permitted in the front leg of a front roll bar or of a lateral roll bar.
- (ii) The front leg must follow the windscreen pillar as closely as possible with the sole bend in its lower near-vertical part.
- (iii) **For non-international Competition**, the front leg may depart from the contour of the windscreen ('A') pillar to enable it to be located rearward of the dashboard.
- (iv) The sole bend permitted in the front leg may be incorporated in its upper part, to enable it to follow the windscreen pillar.
- (v) Each connection between a lateral half roll bar and the main roll bar (J-2), between a longitudinal member and a front or main roll bar (J-3), and between a transversal member and a lateral roll bar (J-4), shall be situated at the roof level.

There shall be not more than four removable connections in the basic structure at the roof level.

NOTE: A removable connection fitted at the top of a backstay is not considered to be at roof level.

(c) **Backstay:**

- (i) Each backstay:
 - (A) shall be attached to the main or lateral roll bar near the roofline;
 - (B) be positioned no further than 100mm from the top outer bend on each side of the *Automobile*;
 - (C) shall not be below the connection of the main roll bar and the front lateral or half lateral roll bar.
 - (D) must form an angle between 30° and 60° from the vertical; and
 - (E) must run rearwards and be straight and be as close as possible to the interior side panels of the bodyshell.
- (ii) A removable connection may be used.
- (iii) For closed sports cars and utilities, and where permitted by the relevant Group technical regulations, the backstays may extend beyond the interior/cockpit of the *Automobile* in order to achieve an angle between 30° and 60° with the vertical. If the required angle cannot be achieved, certification by *Motorsport Australia* is required.

12.2 DESIGN:

In addition to the basic structure, the safety cage must be completed by the addition of compulsory members and reinforcements to which optional members and reinforcements may be added (see Article 15).

12.3 COMPULSORY MEMBERS AND REINFORCEMENTS:

(a) **Diagonal Member:**

The safety cage structure designs detailed in Drawings J-5, J-6, J-7, J-8 and J-9 shall be referred to as 'Type 3 Full Safety Cage'.

For a **Competition with a driver only**, the safety cage structure shall be configured in accordance with Drawing J-5, J-6, J-7 or J-8, incorporating at least one continuous diagonal member. If configured in accordance with Drawing J-5 or J-6, the diagonal shall have the upper end attached on the driver's side.

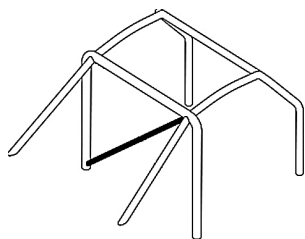

DRAWING J-5

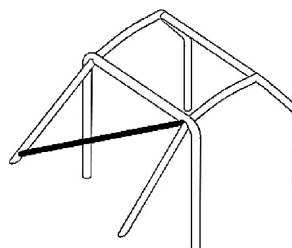

DRAWING J-6

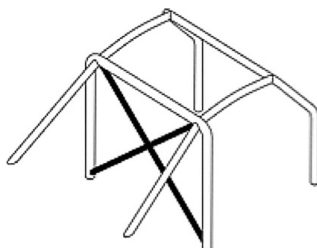

DRAWING J-7

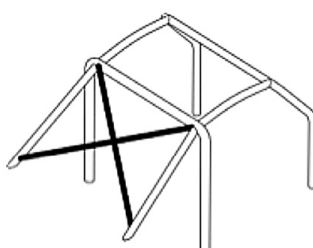

DRAWING J-8

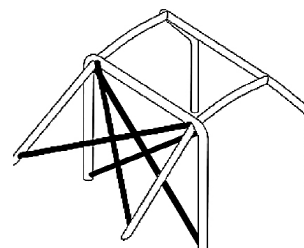

DRAWING J-9

- (i) Each diagonal member may be removable and must be a straight and single continuous piece.
- (ii) For Drawing J-5 the upper end of the diagonal member shall join the main roll bar no further than 100mm from its junction with the backstay. For Drawing J-6 the upper end of the diagonal member shall join the backstay no more than 100mm from its junction with the main roll bar. See Drawing J-62 for the measurement.
- (iii) The lower end of the diagonal shall join the main roll bar or the backstay no further than 100mm from the mounting foot.
- (iv) **For a Competition with more than one occupant**, the safety cage structure shall be configured in accordance with Drawing J-7 incorporating 'double diagonal' members in the main roll bar.
- (v) A 'double diagonal' configuration detailed in Drawing J-7, J-8 or J-9 is recommended in which case:
 - (A) One of the 'double diagonal' members shall be a single continuous piece and shall be straight.
 - (B) The intersection of the diagonal members must be reinforced by at least two gussets in accordance with Article 2.15.
 - (C) The diagonal members may be removable.
 - (D) The lower end of each diagonal shall join the main roll bar or backstays no further than 100mm from the mounting foot (see Drawing J-62 for the measurement).
- (vi) For Drawing J-7 the upper end of each diagonal member shall join the main roll bar no further than 100mm from its junction with the backstay.
- (vii) For Drawing J-8 the upper end of each diagonal member shall join the backstay no more than 100mm from its junction with the main roll bar. See Drawing J-62 for the measurement.
- (viii) In addition to the minimum configuration detailed in Drawing J-7 or J-8, the combination of diagonal members (J7 + J6 or J8 + J5 or J9) may also be used.

(b) **Door bars:**

For an Off Road *Competition*, State Championship and above level Race and Rally *Competition* (and recommended in any other *Competition*):

- (i) One or more door bars must be fitted at each side of the *Automobile* according to Drawings J-10, J-11, J-12 or J-13.
- (ii) For State Rally Championships and above, it is mandatory that 2 or more door bars shall be fitted at each side of the *Automobile* in accordance with Drawings J-11, J-12 or J-13.

- (iii) Door bars may be removable, subject to the use of dismantable joints complying with Article 16.
- (iv) The side protection shall be as high as possible, subject to its upper attachment point not being higher than half the height of the door opening measured from its base.
- (v) If these upper attachment points are located in front of or behind the door opening, this height limitation is for the intersection of the door bar and the door opening. Refer Drawing J-59.
- (vi) In the case of door bars in the form of an "X" (Drawing J-11) it is mandatory that this joint be reinforced by two gussets in accordance with Article 2.15 (see Drawing J-59). It is recommended that the "X" be formed by two continuous bars which are joined in the centre, in which case a gusset reinforcement must be fitted.
- (vii) In accordance with the requirements for a windscreen pillar reinforcement the connection of the windscreen pillar reinforcement (Drawing J-17) to the door bar/s is permitted.

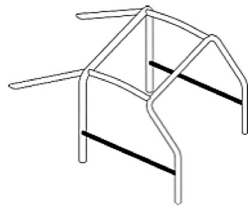

DRAWING J-10

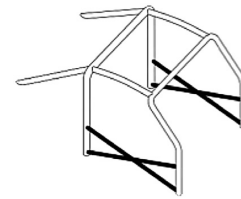

DRAWING J-11

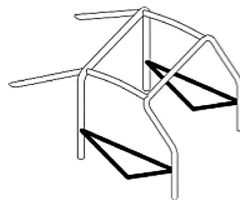

DRAWING J-12

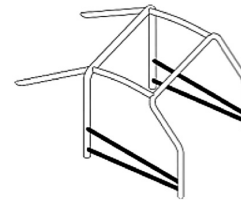

DRAWING J-13

(c) **Roof Reinforcement:**

For each Off Road, National Race and State and above level Rally *Competition*, (and recommended in any other *Competition*).

- (i) The upper part of the safety cage structure shall comply with Drawing J-14, J-15 or J-16. However, for a driver only *Competition*, in the case of Drawing J-14, only one diagonal member is required subject to its front connection being on the driver's side.
- (ii) The reinforcements may follow the curve of the roof.
- (iii) The ends of the reinforcements must be less than 100mm from the junction between roll bars and members (not applicable to the top of the 'V' formed by reinforcements in Drawings J-15 and J-16).
- (iv) The configuration of J-16 shall only be used in conjunction with J-34.
- (v) Where the roof reinforcement is in the form of an "X" (Drawing J-14) it is mandatory that this joint be reinforced by two gussets in accordance with Article 2.15.

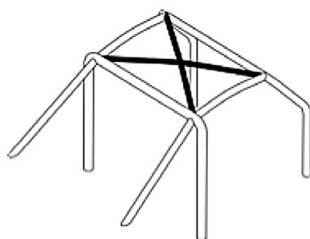

DRAWING J-14

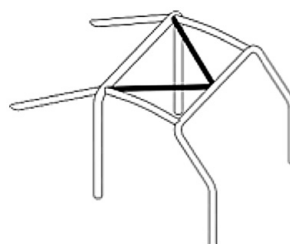

DRAWING J-15

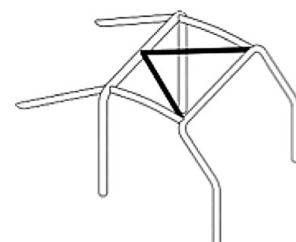

DRAWING J-16

(d) **Windscreen Pillar Reinforcement:**

For each Off Road, National Race and State and above level Rally *Competition* (and recommended in any other *Competition*).

- (i) A windscreen pillar reinforcement member shall be fitted on each side of the front roll bar if dimension "A" is greater than 200mm (refer Drawing J-17).

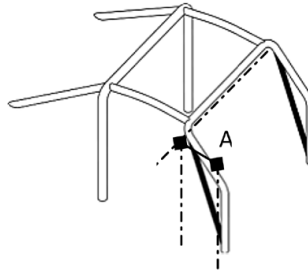

DRAWING J-17

- (ii) The windscreen pillar reinforcement member may be bent on condition that it is straight in side view and that the angle of the bend does not exceed 20°.
- (iii) Its upper end shall be less than 100mm from the junction between the front (lateral) roll bar and the longitudinal (transversal) member (refer Drawing J-62)
- (iv) The lower end shall connect to the front leg and shall be within 100mm of the front mounting foot (refer Drawing J-62).
- (v) If this reinforcement intersects the door bars, it must be split in several parts. The intersection of these joints must be reinforced by at least two gussets in accordance with Article 2.15.

13. SPECIFICATIONS – OPEN AND CLOSED CARS (TYPE 2)

13.1 RACE (OPEN SPORTS CARS), RALLY (SPEED LIMITED), SPEED (STATE LEVEL AND ABOVE) AND DRIFTING:

- (a) Basic Structure: The basic structure shall be constructed according to the following design:

1 main roll bar + 2 backstays + 1 diagonal + 4 mounting feet (refer Drawing J-18 or J-19) this structure shall be referred to as 'Type 2 Half Safety Cage'.

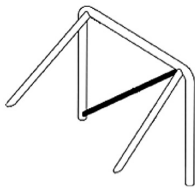

DRAWING J-18

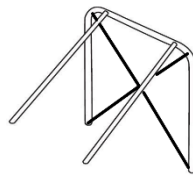

DRAWING J-18 DUAL OCCUPANT

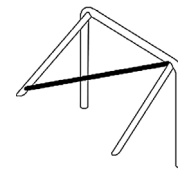

DRAWING J-19

- (b) **General:**

- (i) For each *Automobile* derived from a registrable production *Automobile*, the top of the main roll bar tubing shall be a minimum of 50mm above the top of the driver's helmet when the driver is in the normal seated position.
- (ii) Each *Automobile* which is not derived from a registrable production *Automobile* shall have two rollover structures and shall comply with the following:
- (A) The principal structure shall be positioned behind the driver.
- (B) The secondary structure shall be in front of the steering wheel, but no more than 250mm forward of the top of the steering wheel rim in any position.
- (C) Under no circumstance may the driver's helmet be less than 50mm below a line drawn between the highest points of the principal and secondary structures (refer Drawing J-26).
- (D) In conjunction with the *Automobile's* structure the safety cage structure shall not leave unprotected any part of the driver's shoulders when viewed from front or rear.

- (c) **Stays:**
- (i) For open cars, the stays may be fitted either forward or backward of the main roll bar.
 - (ii) For closed cars, the stays shall only be fitted backward of the main roll bar. Each stay shall be straight and shall form an angle of between 30° and 60° from the vertical.
- (d) **Diagonal Member:**
- (i) The safety cage structure shall have a diagonal member configured as defined in Drawing J-18 or J-19 with the upper end of the diagonal attached on the driver's side.
 - (ii) **For a Competition with more than one occupant**, the safety cage structure shall be configured in accordance with Drawing J-18 Dual Occupants incorporating 'double diagonal' members in the main roll bar.
 - (iii) Each diagonal member shall be straight and may be removable.
 - (iv) The upper end of the diagonal shall join the main roll bar within 100mm of its junction with the backstay, or the backstay within 100mm of its junction with the main roll bar (refer Drawing J-62 for the measurement).
 - (v) One or more additional diagonal member/s is recommended, and a double diagonal configuration is permitted in the main roll bar and between the stays (refer Drawing J-20).

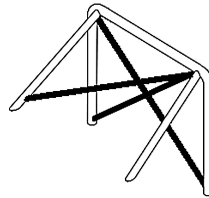

DRAWING J-20

- (e) **Additional Bracing:**
- (i) A forward mounted reinforcement is permitted (refer Drawing J-21).

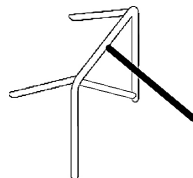

DRAWING J-21

- (A) The lower portion of this reinforcement may be mounted in the front passenger space, in which case a passenger is not permitted.
 - (B) Where fitted, the driver's helmet shall be at least 50mm from the member when seated in the normal driving position.
 - (C) A seat incorporating a lateral head restraint is recommended. Refer also to Article 11.1 regarding protective padding.
- (ii) If door bars are incorporated into a Type 2 Half Safety Cage, the forward end of each door bar member or the reinforcement detailed in Drawing J-21 shall be fitted with a mounting foot which shall be attached to the bodyshell/chassis in accordance with Article 18.
 - (iii) It is recommended that each *Competitor* consider the fitment of additional reinforcing members and/or a Type 3 Full Safety Cage.
 - (iv) For an open car fitted with a Type 3 Full Safety Cage, the basic structure detailed in Article 12.1 is the minimum requirement for the elements of the safety cage structure forward of the main roll bar, regardless of *Event* status unless a higher specification is mandated in the regulations applying to that *Competition*.

13.2 RALLY AND OFF ROAD:

Each open *Automobile* used in a Rally/Road or Off Road *Event* must be fitted a Type 3 Full Safety Cage structure which incorporates one of the roof reinforcement options detailed in Drawing J-14, J-15 or J-16, regardless of *Event* status, except as detailed in Article 3.4(c).

13.3 TARGA ROOF AUTOMOBILES (NOT APPLICABLE FOR RALLY/ROAD OR OFF ROAD EVENTS):

A targa roof is one where the top of the front windscreen support is connected to the rear window ('B') pillar, if fitted, but only in a narrow section inboard of the tops of the windscreen (or 'A') pillars or where there is no permanent connection at roof level between the A and B pillars.

An *Automobile* deemed to have a targa roof may compete in a race, speed, modern regularity or drift *Event* with a safety cage structure complying with Drawing J-22, J-23 or J-24 and with Article 13.1(a).

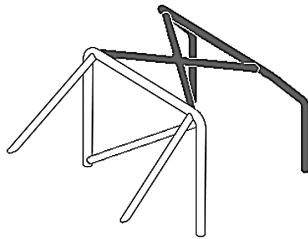

DRAWING J-22

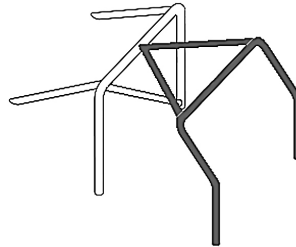

DRAWING J-23

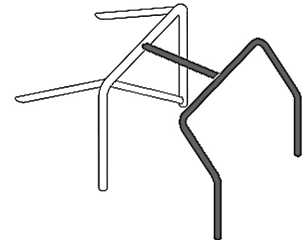

DRAWING J-24

14. SPECIFICATIONS – SINGLE-SEAT CARS (TYPE 1)

Except where varied by this regulation or Group or Technical regulations approved by *Motorsport Australia*, a purpose designed single seat *Automobile* shall comply with this Article. This article shall not apply to an *Automobile* in which the passenger seat has been removed nor to any *Automobile* in Off Road *Competition*.

14.1 OPEN COCKPIT CARS:

Each *Automobile* shall be fitted with a principal structure and a secondary structure.

(a) Principal Structure:

- (i) The principal structure shall consist of a main roll bar and a backstay as a minimum (refer Drawing J-25). This structure shall be referred to as 'Type 1 Solo Roll Bar'.

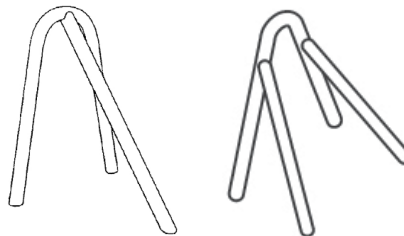

DRAWING J-25

- (ii) The principal structure must be positioned behind the driver.
- (iii) The main roll bar shall be made in one piece, without joints.
- (iv) There shall be at least one brace from the top of the main roll bar.
- (v) The brace/s shall form an angle between 30° and 60° with the vertical.
- (vi) The diameter and material of the brace/s shall comply with Article 8.3.
- (vii) Where two braces are used, they may be fitted both sides of the roll bar and shall be within 100mm of the top of the main roll bar.
- (viii) The stays may face rearward and/or forward.
- (ix) The main roll bar (together with any additional members and/or a head rest) shall be configured such that the driver's helmet cannot pass through it.
- (x) The bend radius on the centreline of the main roll bar shall be between two and four times the tube diameter.
- (xi) In conjunction with the *Automobile's* structure, the main roll bar shall not leave unprotected any part of the driver's shoulders, when viewed from the front or rear.

- (xii) Each leg of the main roll bar shall be straight from the uppermost bend to within 100mm of where it meets the chassis.
- (xiii) Any removable connection shall comply with Drawings J-47 to J-56.
- (xiv) Under no circumstance may the driver's helmet be less than 50mm below a line drawn between the highest points of the principal and secondary structures (refer Drawing J-26).

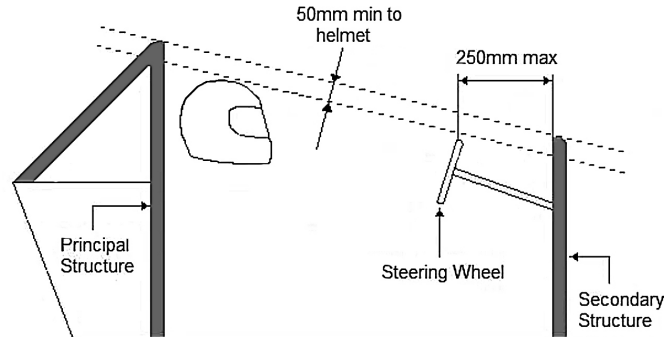

DRAWING J-26

(b) **Secondary Structure:**

A substantial secondary structure shall be incorporated forward of the steering wheel, but no more than 250mm forward of the top of the steering wheel rim.

14.2 CLOSED CARS:

Each *Automobile* shall be fitted with a safety cage structure complying as a minimum with Drawing J-5, J-6, J-7 or J-8 and Article 12. Refer also to Compulsory Members and Reinforcements.

14.3 ALTERNATIVE DESIGNS:

A safety cage structure not in compliance with Schedule J specifications may be approved through the *Motorsport Australia* certification process. The static load tests detailed in by the *FIA* shall apply. Approval in principle for any proposed design shall be sought from *Motorsport Australia* prior to commencement of construction.

15. REINFORCEMENT OF BENDS, JUNCTIONS AND TUBES- GUSSETS

- (a) A minimum of two gussets complying with Article 2.15 (and Drawing J-1), for safety cages registered on or after 1 July 2018, shall be fitted onto the following junctions between the:
 - (i) diagonal members of the main roll bar or rear backstay (Type 3 Drawing J-7, J-8, J-9 and Type 2 Drawing J-20);
 - (ii) roof reinforcements (Drawing J-14);
 - (iii) door bars (Drawing J-11); and
 - (iv) door bars and the windscreen pillar reinforcement (Drawing J-17).
- (b) If a door bar and the windscreen pillar reinforcement (where fitted) are not in the same plane (intersecting), the reinforcement gusset/s may run horizontally or vertically and be fabricated from sheet metal.
- (c) Any hole in a tube forming part of a safety cage structure shall be fitted with a bush, the wall thickness of which is at least the same as that of the tube. The bush shall be welded around its whole perimeter at both exit points.

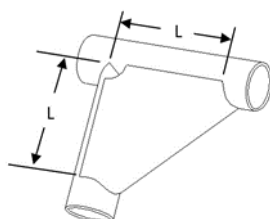

DRAWING J-1

15.1 OPTIONAL MEMBERS AND REINFORCEMENTS:

(a) **General:**

Except where otherwise specified in Articles 12, 13 and 14 members and reinforcements shown in Drawings J-14 to J-16, J29 to J-33 and J-35 to J-45 are optional.

(i) Installation shall be by welding or by dismantable joints detailed in these regulations.

(ii) Members and reinforcements may be used separately or in combination.

(b) **Backstay Diagonals** (Drawing J-33):

The configuration of Drawing J-33 may be replaced with that of Drawing J-34 only if a roof reinforcement complying with Drawing J-16 is used.

(c) **Front Suspension Mounting Points** (Drawing J-37):

Where fitted, they shall be mounted to the front suspension top mounting points.

(d) **Transversal Members** (Drawings J-38 to J-42):

(i) The transversal member fixed to the front roll bar shown on Drawing J-41 shall not encroach upon the space reserved for the occupants and shall not be positioned below the steering column.

(ii) The transversal member shall be placed as high as possible subject to its lower edge not being higher than the uppermost point of the dashboard.

(iii) For members shown on Drawings J-38 and J-39, the angle between the central leg and the vertical shall be at least 30°.

(e) **Safety Harness Mounting to a Transversal Member:**

(i) Welded transversal members fitted on the main roll bar or between the backstays may be used for the safety harness mountings provided the installation complies with Schedule I.

(ii) It is highly recommended that the requirements for FHR are observed for positioning of mountings for shoulder straps.

(iii) The harness shall be installed in accordance with the manufacturer's instructions and Schedule I.

(iv) Any bolted attachment shall comply with Drawing J-28. Where a bush is inserted (which may be threaded) the bush shall be welded around its whole perimeter at both exit points.

(v) The harness/es shall be mounted using bolts of M12 8.8 (ISO standard) or 7/16UNF or to manufacturer's specification.

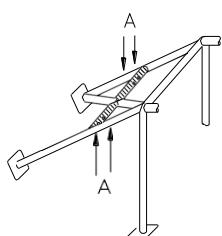

DRAWING J-27

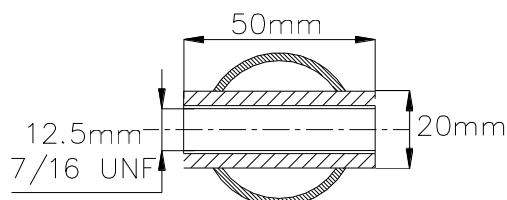
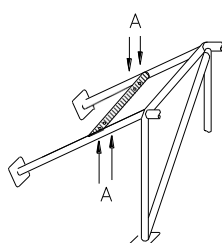

DRAWING J-28

15.2 REINFORCEMENT OF BENDS AND JUNCTIONS:

Reinforcements shall consist of tubes or gussets made from sheet metal formed into a U-shape complying with Article 2.15. The end of a tubular reinforcement shown in Drawings J-43, J-44 and J-46 shall not be attached beyond the mid-point of the member.

16. REMOVABLE MEMBERS

- (a) Removable members may be incorporated subject to the use of dismantable joints complying with Drawings J-47 to J-57 or a joint Homologated by the *FIA* or *Motorsport Australia* or other ASN with the approval of *Motorsport Australia*. Such joints shall not be welded once assembled.
- (b) Any fastener used shall have a minimum quality of 8.8 (ISO standard).
- (c) Dismantable joints complying with Drawings J-47, J-50, J-53, J-56 and J-57 shall be used only for attaching removable members and reinforcements described by Article 12.3. They are not permitted for joining the upper parts of the main roll bar, the front roll bar, the lateral half roll bars or the lateral roll bars (refer Drawings J-2, J-3 and J-4 or a joint Homologated by the *FIA* or *Motorsport Australia* or other ASN with the approval of *Motorsport Australia*).
- (d) The use of dismantable joints as per drawing J-47, J-50, J-53, J-56 and J-57 are not permitted for use [in safety cage structures registered](#) after 31/12/2024.

17. ADDITIONAL CONSTRAINTS

- (a) The safety cage structure shall be entirely contained longitudinally between centrelines of the front and rear axles. For international *Competition*, refer *FIA* regulations.
- (b) Supplementary reinforcements exceeding these limits are authorised between the safety cage structure and the anchorage points of the rear anti-roll bars on the bodyshell/chassis. Each of these anchorage points may be connected to the safety cage structure by a single tube with maximum dimensions of 30mm x 1.5mm.
- (c) In frontal projection, no additional member or reinforcement of the front roll bar (including the front legs) shall be visible beyond the shaded area of the windscreen, as shown in Drawing J-58.
- (d) In side projection, any reinforcements in the front door aperture shall comply with the following criteria (refer Drawing J-59):
 - (i) Dimension A shall be a minimum of 300mm
 - (ii) Dimension B shall be a maximum of 250mm
 - (iii) Dimension C shall be a maximum of 300mm
 - (iv) Dimension E shall not be more than half the height of the door aperture (H).

18. MOUNTING OF THE SAFETY CAGE STRUCTURE TO THE BODYSHELL/CHASSIS

18.1 MINIMUM MOUNTING POINTS:

The minimum mounting points are:

- (i) one for each pillar of the front roll bar;
- (ii) one for each pillar of the lateral roll bars or lateral half roll bars;
- (iii) one for each pillar of the main roll bar;
- (iv) one for each backstay.

18.2 MOUNTING POINTS OF THE FRONT, MAIN AND LATERAL ROLL BARS OR LATERAL HALF ROLL BARS:

- (a) Each mounting point shall include a mounting foot consisting of a plate at least 3mm thick.
- (b) Where attached by bolts, each mounting foot shall be attached by at least three bolts to a steel reinforcement plate at least 3mm thick and of at least 120cm² area which is welded to the bodyshell.
- (c) Where attached by bolts, the angle between any two bolts shall not be less than 60° (measured from the tube axis at the level of the mounting foot circumference – Drawing J-60).
- (d) The area of 120cm² of the reinforcement plate shall be the contact surface between the reinforcement plate and the bodyshell. Refer Drawings J-60 to J-66. For Drawing J-62 the reinforcement plate need not be welded to the bodyshell.
- (e) Fasteners shall have a minimum diameter of M8 and a minimum quality of 8.8 (ISO standard) and shall be self-locking or fitted with lock washers.

(f) Mounting Points - non-international use only

As an alternative to welding reinforcement plates to the chassis of the *Automobile* detailed in Article 18.2 and 18.3, each attachment point of the safety cage structure may be fitted with a mounting foot and counter plate complying with Table J-3 below (see also Drawing J-69).

The mounting foot, complying with the area requirements shown below may be welded to the bodyshell or be a fully welded mount structure (box) to the bodyshell, in which case the use of bolts and the counter plate is not required (see Drawing J-70).

TABLE J-3

Mounting Foot Application	Minimum Area	Minimum Single Dimension
Automobiles under 700kg	65cm ²	55mm
701kg to 1150kg	75cm ²	65mm
Over 1151kg	100cm ²	75mm
Counterplate	45cm ²	Matching upper plate

18.3 MOUNTING POINTS OF THE BACKSTAYS:

- (a) Each backstay shall be secured by at least two M8 (minimum) 8.8 (ISO standard) bolts with mounting feet of an area at least 60cm² (refer Drawing J-67).
- (b) Alternatively, it shall be secured by a single M10 8.8 (ISO standard) bolt in double shear (refer Drawing J-68), provided each mounting plate is at least 3mm thickness steel with a bush fully welded into the backstay.

NOTE: Refer also to Article 18.2(c) for alternate provisions for non-international safety cage structures.

18.4 ADDITIONAL FASTENERS AND WELDING:

- (a) Additional fasteners and/or fasteners of larger dimensions may be used.
- (b) The safety cage may be attached to the bodyshell/chassis by welding or bolting in locations additional to the minimum mounting points detailed in Article 18.1.

18.5 SPECIAL CASES:

(a) **Non-steel bodyshells/chassis:**

- (i) For non-steel bodyshells/chassis, any welding between the safety cage structure and the bodyshell/chassis is prohibited.
- (ii) In addition to mounting by bolts, only the bonding of the reinforcement plate to the bodyshell/chassis is permitted.

(b) **Spaceframe Construction:**

- (i) The safety cage structure of a spaceframe constructed *Automobile* shall comply with Schedule J from at least above the predominantly horizontal portion of the chassis.

Parts of the safety cage structure may extend below this horizontal plane and become integral with the chassis. The safety cage structure shall also comply with any relevant Group or other technical regulations.

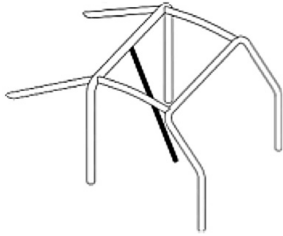

DRAWING J-29

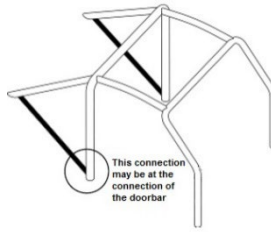

DRAWING J-30

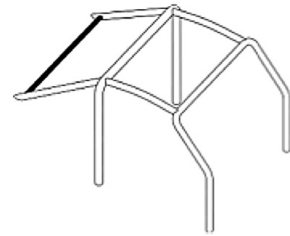

DRAWING J-31

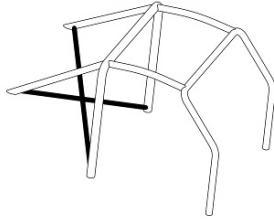

DRAWING J-32

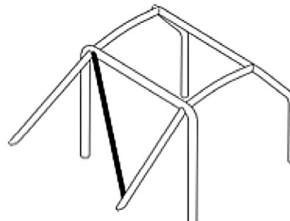

DRAWING J-33

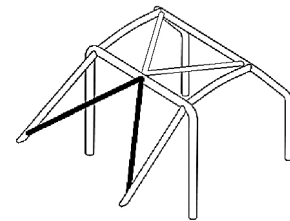

DRAWING J-34

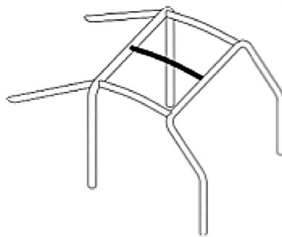

DRAWING J-35

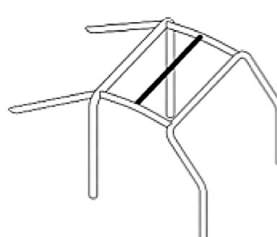

DRAWING J-36

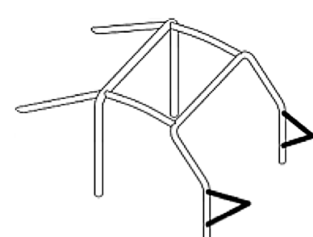

DRAWING J-37

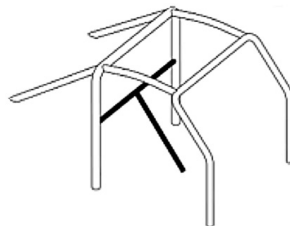

DRAWING J-38

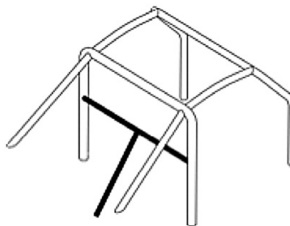

DRAWING J-39

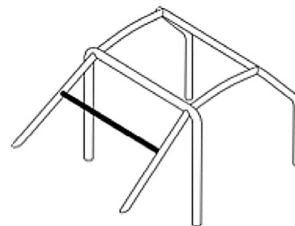

DRAWING J-40

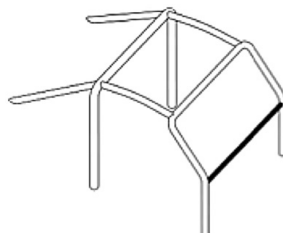

DRAWING J-41

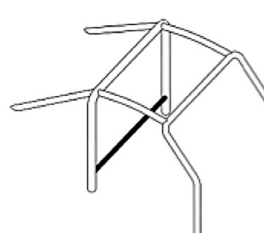

DRAWING J-42

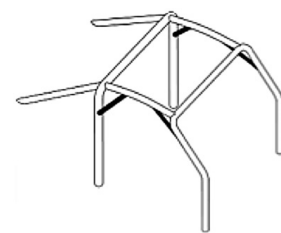

DRAWING J-43

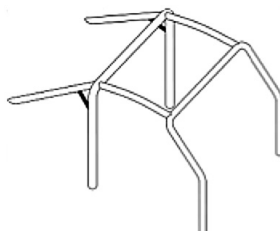

DRAWING J-44

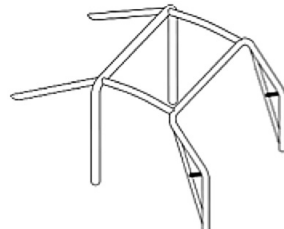

DRAWING J-45

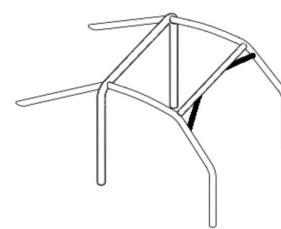

DRAWING J-46

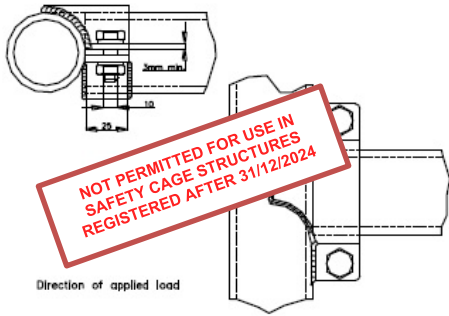

NOT PERMITTED FOR USE IN SAFETY CAGE STRUCTURES REGISTERED AFTER 31/12/2024

DRAWING J-47



NOT PERMITTED FOR USE IN SAFETY CAGE STRUCTURES REGISTERED AFTER 31/12/2023

DRAWING J-48



NOT PERMITTED FOR USE IN SAFETY CAGE STRUCTURES REGISTERED AFTER 31/12/2023

DRAWING J-49

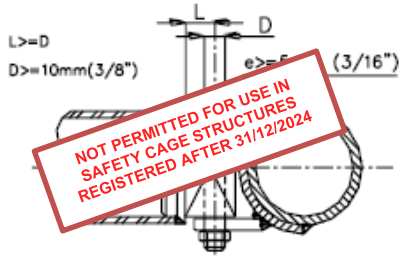

NOT PERMITTED FOR USE IN SAFETY CAGE STRUCTURES REGISTERED AFTER 31/12/2024

DRAWING J-50

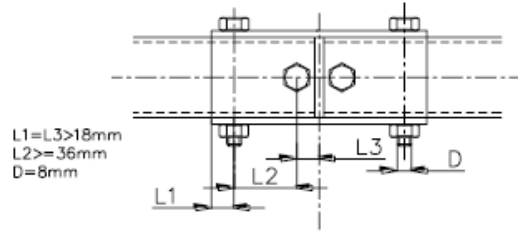

DRAWING J-51

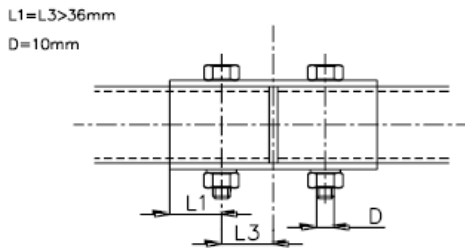

DRAWING J-52

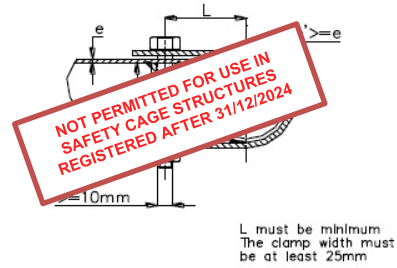

NOT PERMITTED FOR USE IN SAFETY CAGE STRUCTURES REGISTERED AFTER 31/12/2024

L must be minimum
The clamp width must be at least 25mm

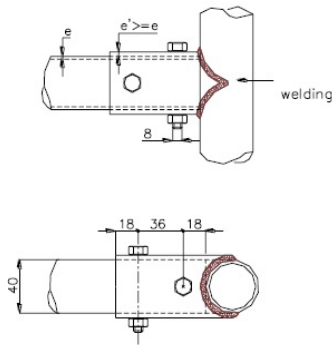

DRAWING J-54

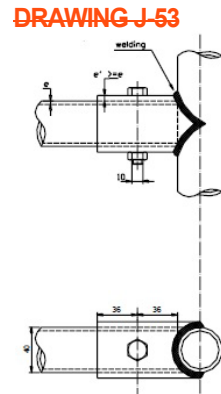

DRAWING J-55

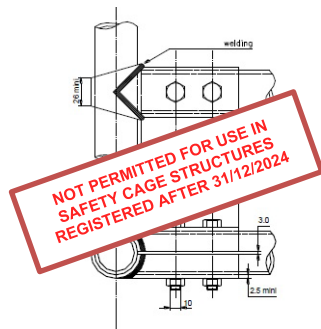

NOT PERMITTED FOR USE IN SAFETY CAGE STRUCTURES REGISTERED AFTER 31/12/2024

DRAWING J-56

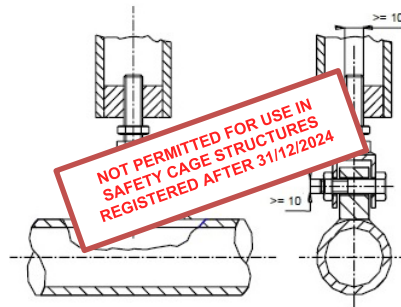

NOT PERMITTED FOR USE IN SAFETY CAGE STRUCTURES REGISTERED AFTER 31/12/2024

DRAWING J-57

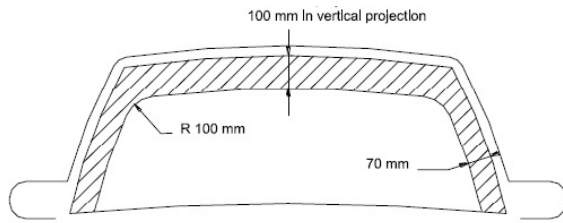

DRAWING J-58

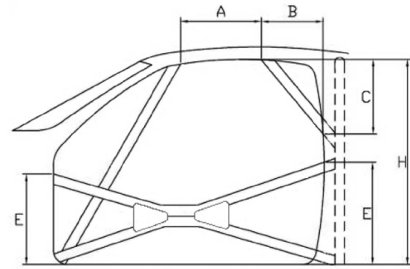

DRAWING J-59

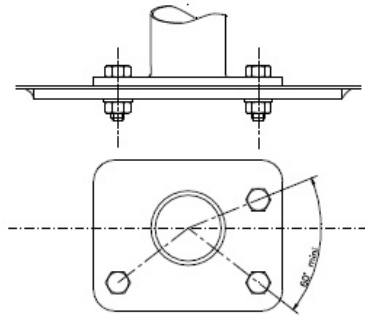

DRAWING J-60

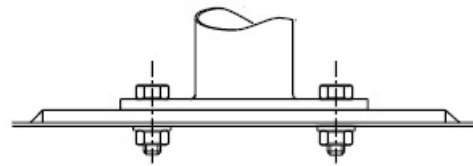

DRAWING J-61

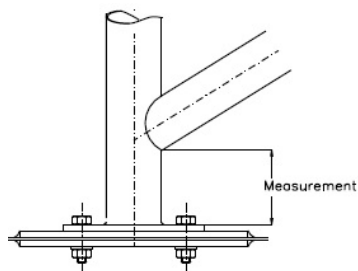

DRAWING J-62

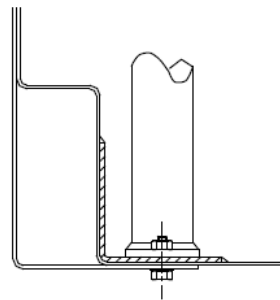

DRAWING J-63

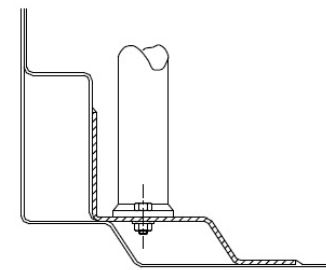

DRAWING J-64

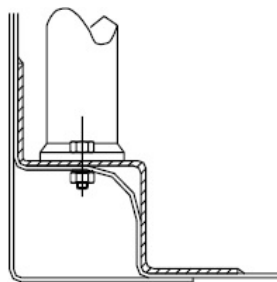

DRAWING J-65

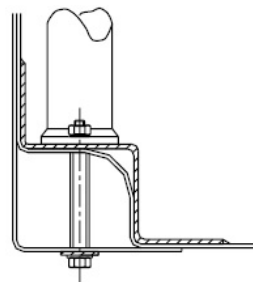

DRAWING J-66

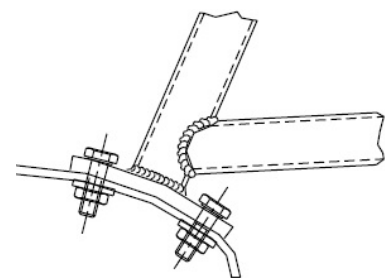

DRAWING J-67

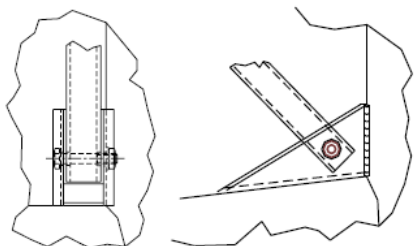

DRAWING J-68

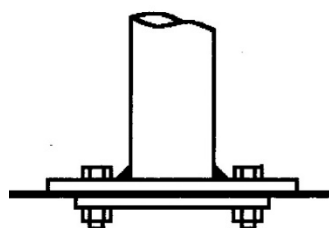

DRAWING J-69

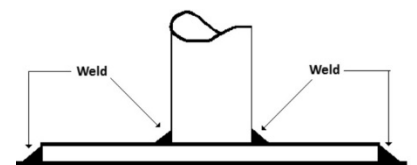

DRAWING J-70